



Fun 
in
the Sun

PATTERN BOOK

July 17-18, 2021

8AM each day



Judges



Saturday 7/17:

Casey Orr

Mark Baus

Sunday 7/18:

Alisa Bernhard-Proefrock

Kimberly Garrett



Showmanship

Age Division

22. Amateur W-T

Show: IPHC Fun In The Sun

Date: Jul 17, 2021

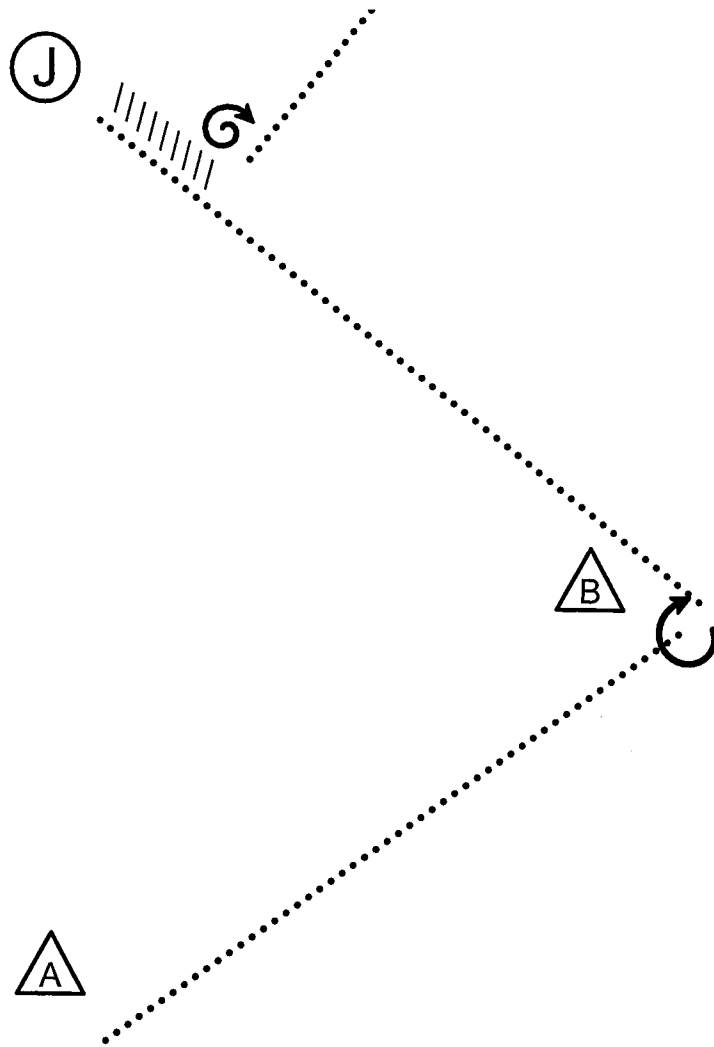

Be ready at A

1. Walk past B and stop
2. Perform a 270° turn
3. Walk to the judge
4. Stop and set up for inspection
5. When dismissed back one horse length
6. Perform a 450° turn and walk to the line-up

Follow the instructions of your ring steward

*Generated from Equiscribe for iOS
Scan the code to see your results as they are posted*

Showmanship

Show: IPHC Fun In The Sun

Date: Jul 17, 2021

Age Divisions

- 23. Youth W-T 5-10
- 24. Youth W-T 11-18
- 25. Novice Youth
- 26. Youth 13 & Under
- 27. Youth 18 & Under
- 28. Novice Amateur
- 29. Amateur

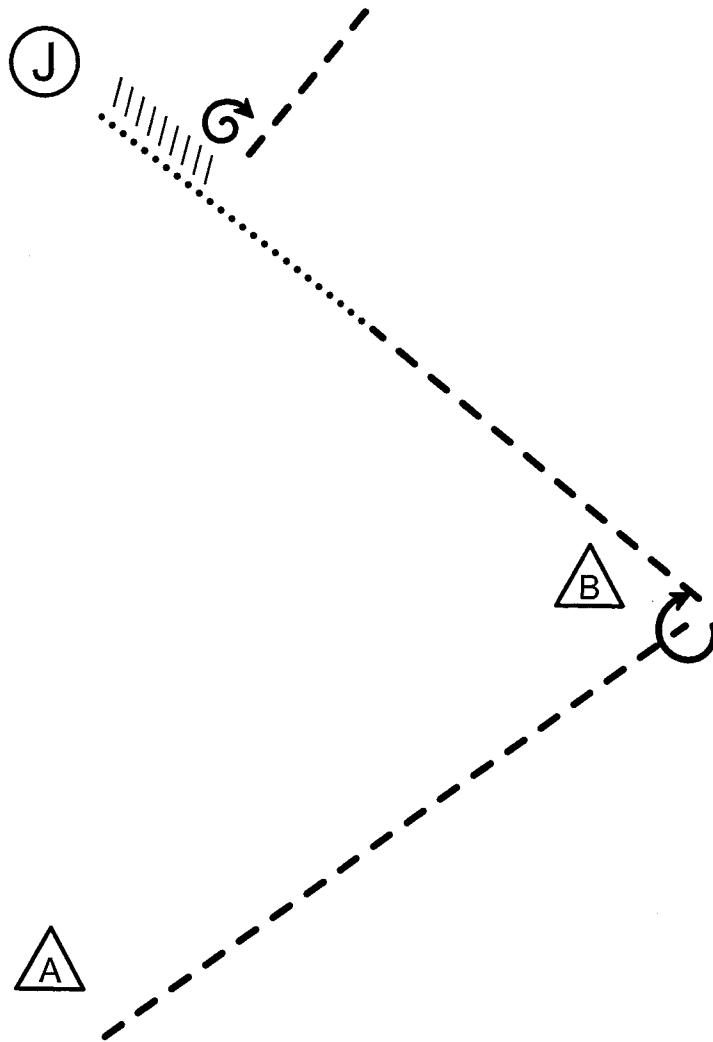

Be ready at A

1. Trot past B and stop
2. Perform a 270° turn
3. Trot halfway to the judge
4. Break to the walk and walk to the judge
5. Stop and set up for inspection
6. When dismissed back one horse length
7. Perform a 450° turn and trot to the line-up

Follow the instructions of your ring steward

Generated from Equiscribe for iOS
Scan the code to see your results as they are posted

English Equitation

Age Divisions

85. Youth W-T 5-10

86. Amateur W-T

Show: IPHC Fun In The Sun

Date: Jul 17, 2021

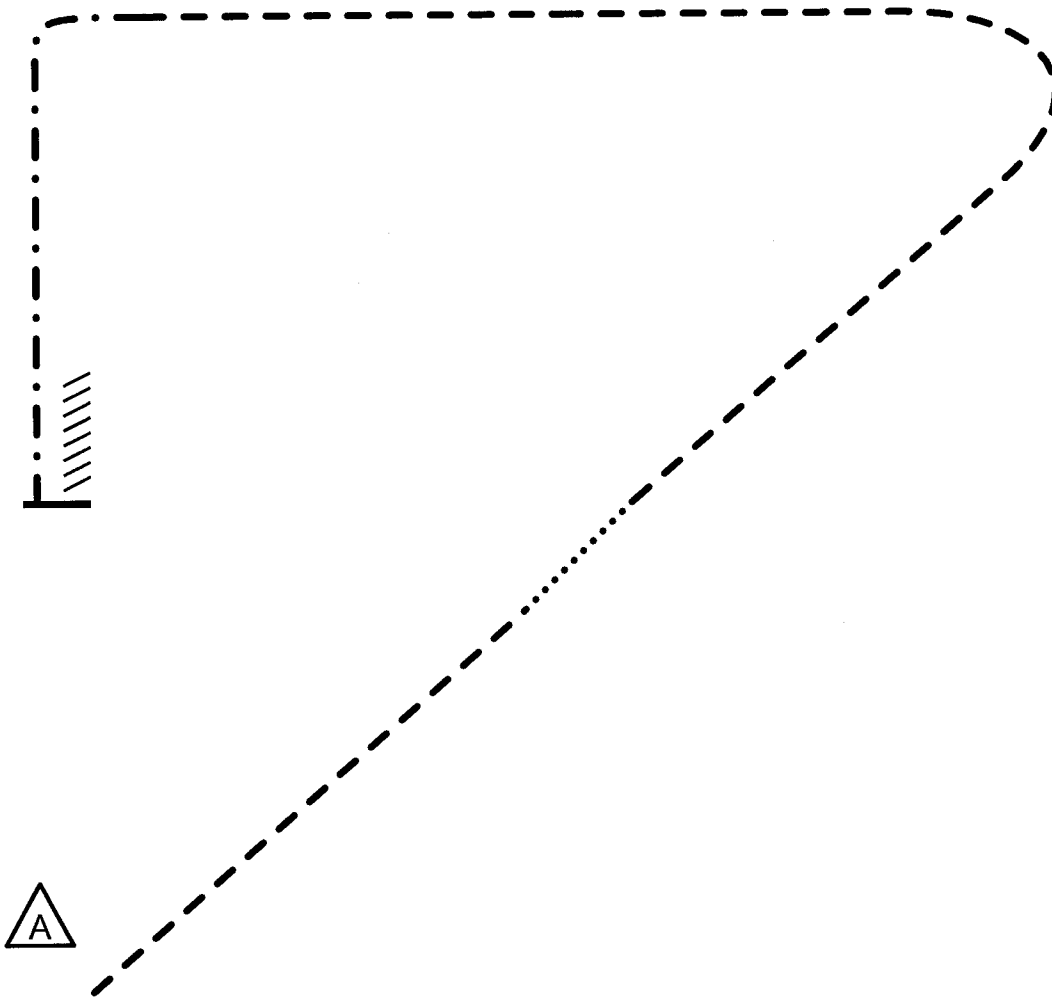

Be ready at A

1. Trot right diagonal
2. Walk 10 steps
3. Trot on the left diagonal to the corner
4. Change diagonals and trot to next corner
5. At corner, perform a sitting trot halfway to A
6. Stop when halfway to A and back approximately one horse length

English Equitation

Show: IPHC Fun In The Sun

Date: Jul 17, 2021

Age Divisions

95. Novice Youth

96. Youth 13 & Under

97. Youth 18 & Under

98. Novice Amateur

99. Amateur

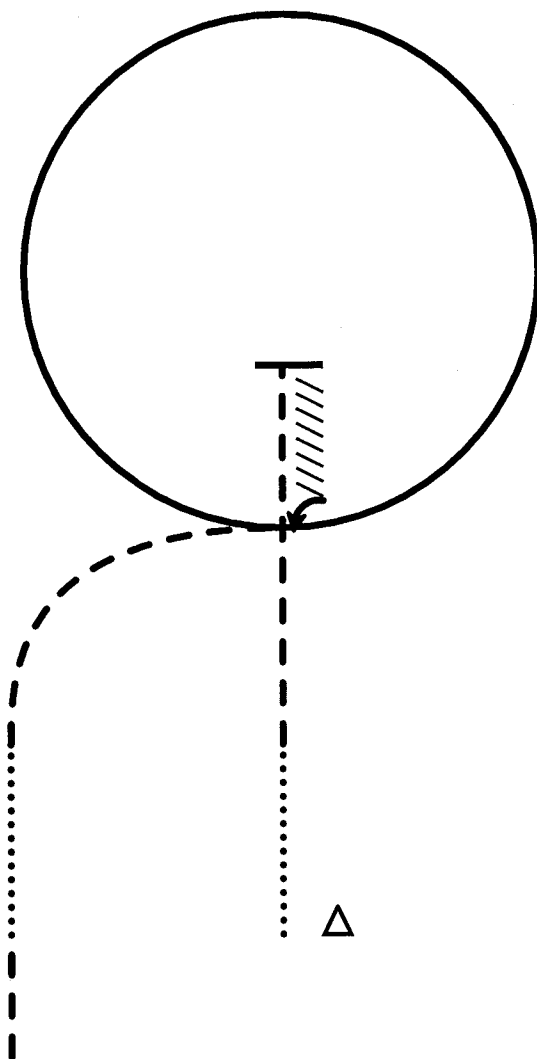

Be ready at A

1. Walk two horse lengths then posting trot on the left diagonal past the center of the arena
2. Stop and back approximately two horse lengths
3. Perform a 90° turn on the forehand to the left
4. Canter a circle on the right lead
5. Posting trot on the right diagonal then walk two horse lengths Exit at a sitting trot

Horsemanship

Age Divisions

105. Youth W-T 5-10

106. Amateur W-T

Show: IPHC Fun In The Sun

Date: Jul 17, 2021

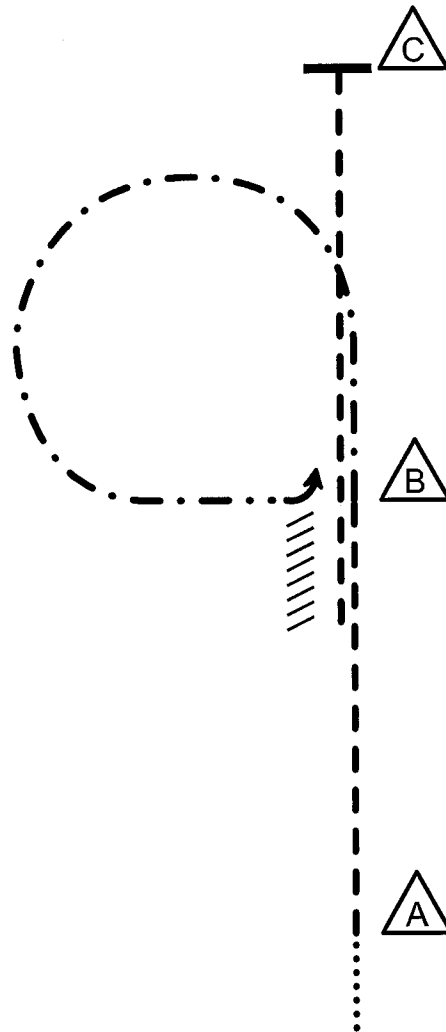

Pattern design by NULL

Begin before A

1. Walk to A
2. Jog from A to B
3. At B, extend the jog and cricle at B as shown. Stop facing B
4. Turn 90° to the left
5. Back one horse length
6. Jog to C. Stop at C.

Follow the instructions of your ring steward

*Generated from Equiscribe for iOS
Scan the code to see your results as they are posted*

Horsemanship

Show: IPHC Fun In The Sun
Date: Jul 17, 2021

Age Divisions

117. Novice Youth
118. Youth 13 & Under
119. Youth 18 & Under
120. Novice Amateur
121. Amateur

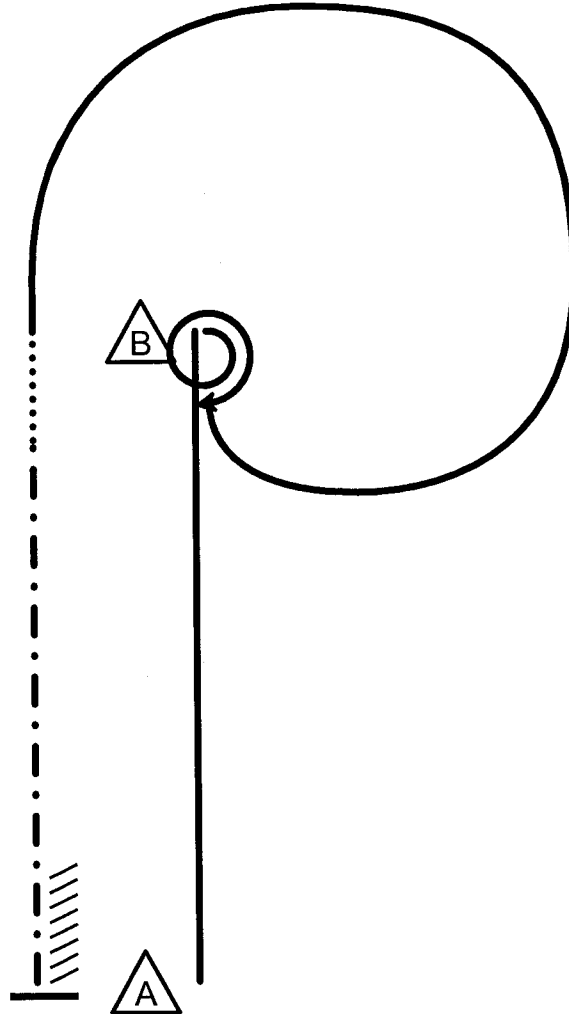

Be ready at A

1. Lope on the right lead to B
2. Turn 540° right
3. Lope on the left lead around to B
4. Break to walk, walk approximately 10 feet
5. Extended jog to A
6. Stop at A and back one horse length

Follow the instructions of your ring steward

Generated from Equiscribe for iOS
Scan the code to see your results as they are posted

Western Riding

Age Divisions

122. Youth 18 & Under

125. Amateur

126. Open

Show: IPHC Fun In The Sun

Date: Jul 17, 2021

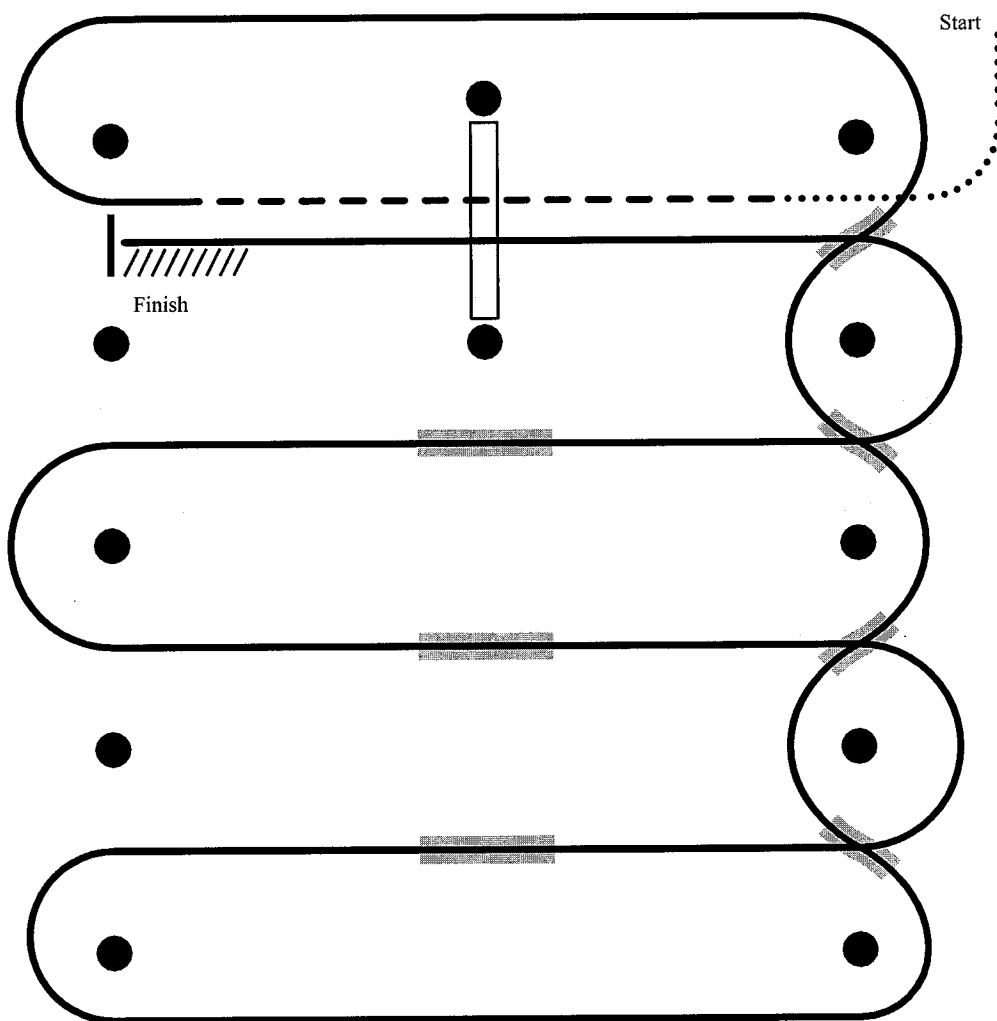

1. Walk, transition to jog, jog over log
2. Transition to the lope, lope around end
3. First line change
4. Second line change
5. Third line change
6. Fourth line change
7. First crossing change
8. Second crossing change
9. Third crossing change
10. Lope over log
11. Lope, stop & back

Generated from Equiscribe for iOS
Scan the code to see your results as they are posted

Western Riding

Age Divisions

123. Green

124. Novice Amateur

Show: IPHC Fun In The Sun

Date: Jul 17, 2021

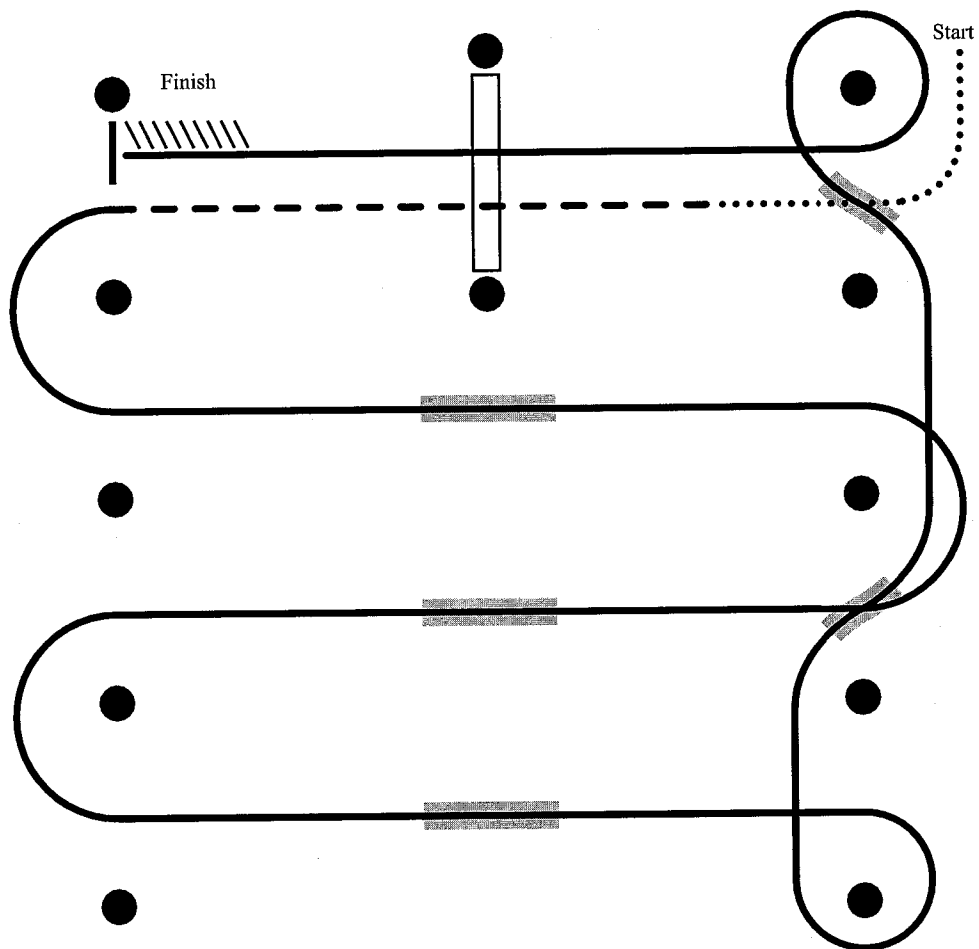

1. Walk, transition to jog, jog over log
2. Transition to left lead lope
3. First crossing change
4. Second crossing change
5. Third crossing change
6. circle and first line change
7. Second line change and circle
8. Lope log
9. Stop and back

Generated from Equiscribe for iOS
Scan the code to see your results as they are posted

Trail

Age Divisions

127. Yearling In-hand

128. Amateur W-T

129. Youth W-T 5-10

Show: IPHC Fun In The Sun

Date: Jul 17, 2021

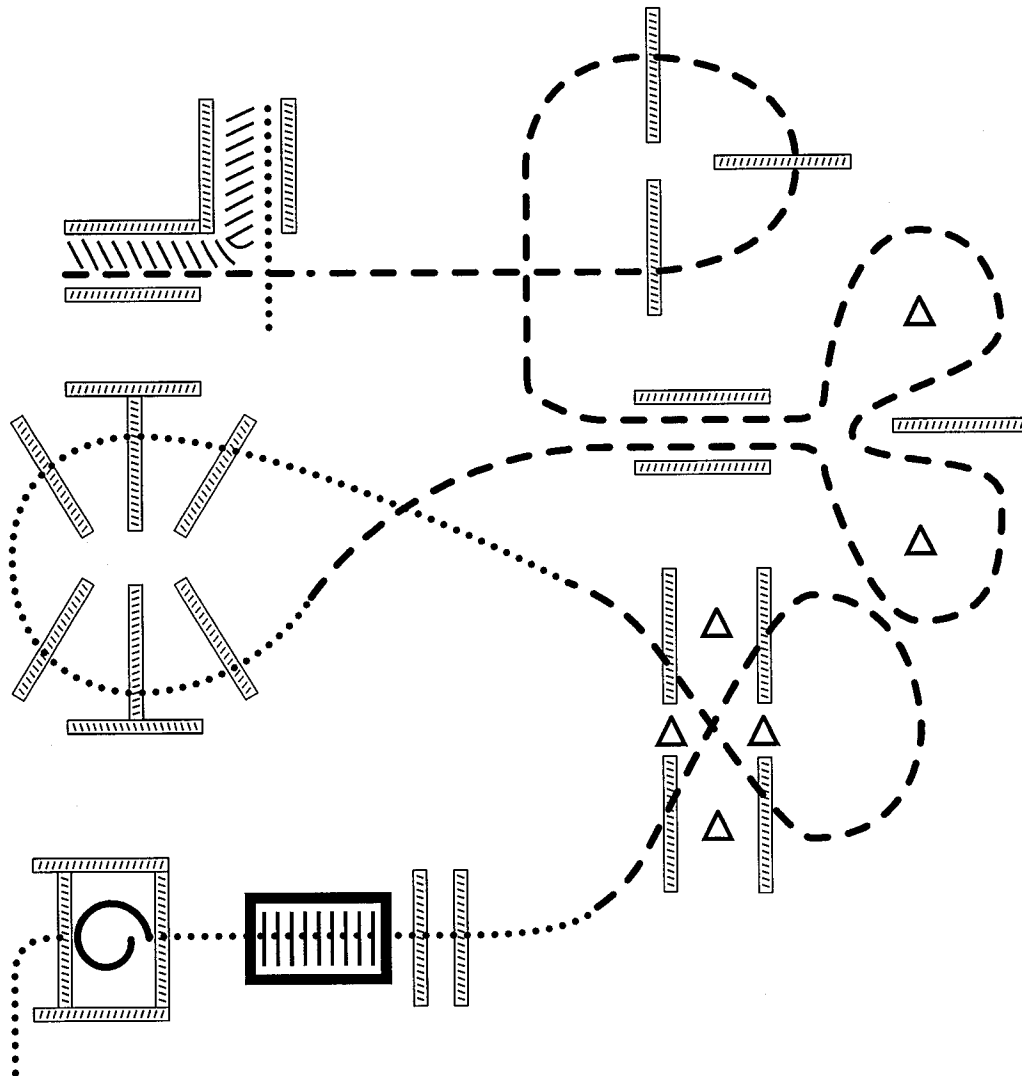

1. Walk into box and perform a 360° turn either direction
2. Walk over bridge and logs
3. Trot logs as shown
4. Walk over logs
5. Trot through chute and around cones as shown
6. Trot over logs
7. Trot into chute and back L
8. Exit at a walk

Generated from Equiscribe for iOS
Scan the code to see your results as they are posted

Trail

Show: IPHC Fun In The Sun

Date: Jul 17, 2021

Age Divisions

- 130. Novice Youth
- 131. Youth 18 & Under
- 132. Green
- 133. Novice Amateur
- 134. Amateur
- 135. Open

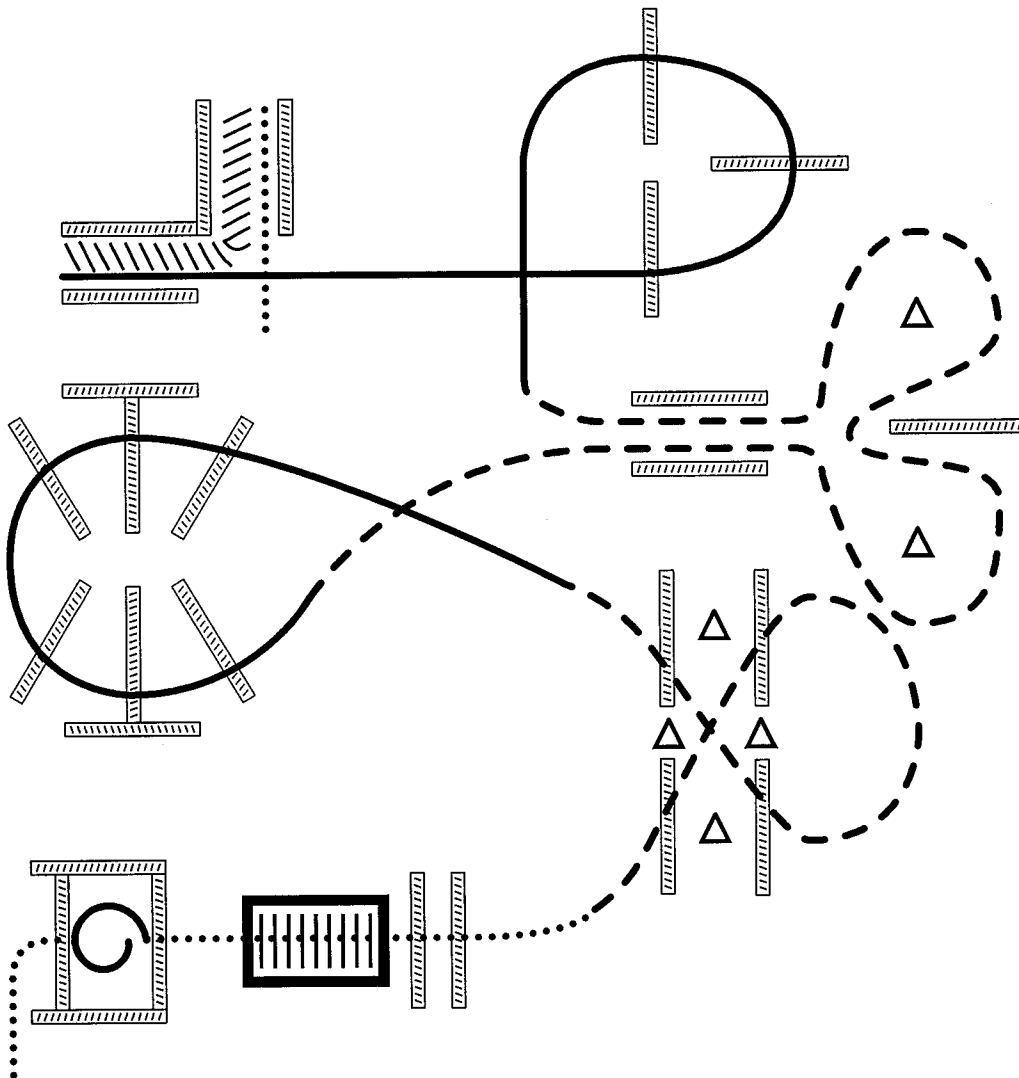

1. Walk into box and perform a 360° turn either direction
2. Walk over bridge and logs
3. Trot logs as shown
4. Lope over logs
5. Trot through chute and around cones as shown
6. Lope over logs
7. Lope into chute and back L
8. Exit at a walk

Generated from Equiscribe for iOS
Scan the code to see your results as they are posted

Ranch Riding

Age Divisions

136. Youth 18 & Under

137. Amateur

138. Open

Show: IPHC Fun In The Sun

Date: Jul 17, 2021

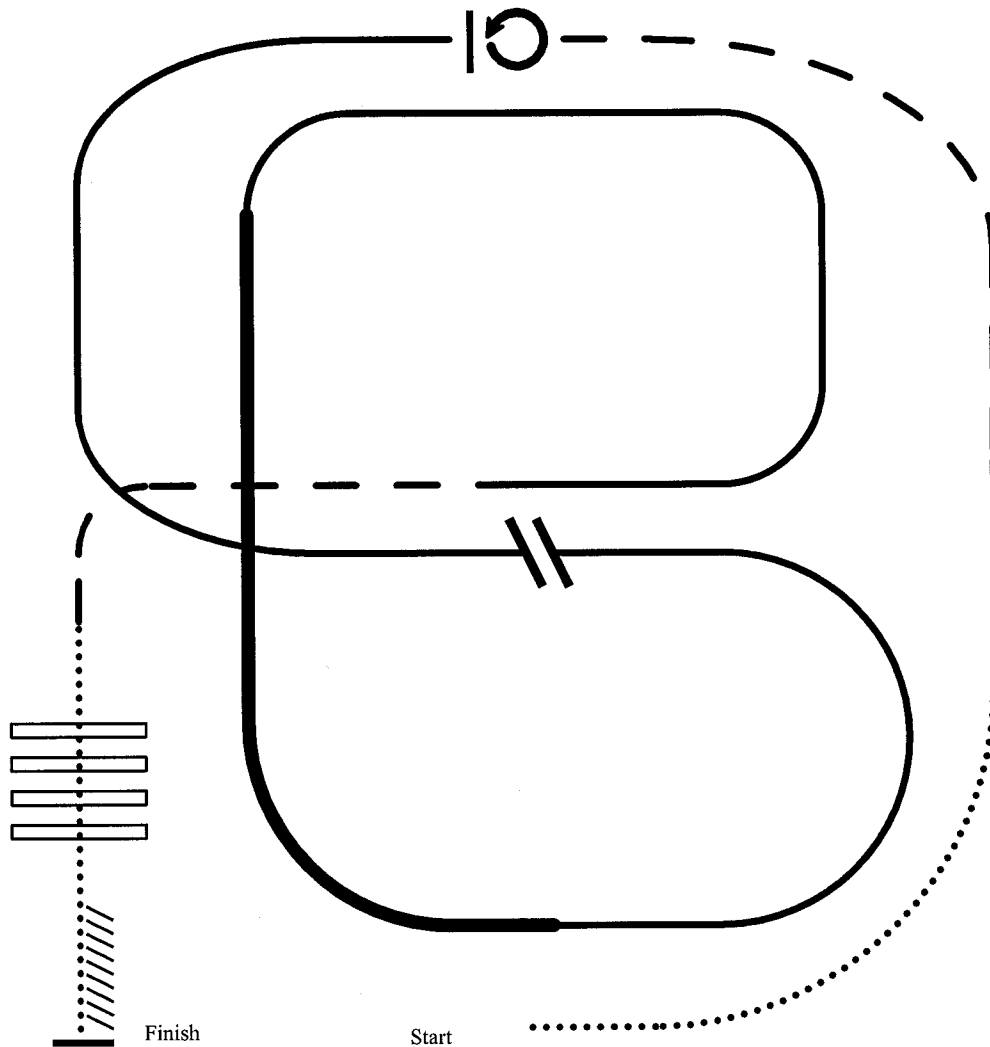

1. Walk
2. Trot
3. Extend the trot; At the top of the arena, stop
4. 360° turn to the left
5. Left lead ½ circle, lope to the center
6. Change leads (simple or flying)
7. Right lead ½ circle
8. Extended lope up the long side of the arena (right lead)
9. Collect back to a lope around the top of the arena and back to center
10. Break down to an extended trot
11. Walk over poles
12. Stop and back

Generated from Equiscribe for iOS
Scan the code to see your results as they are posted

Reining

Age Divisions

139. Youth 18 & Under

140. Amateur

141. Open

Show: IPHC Fun In The Sun

Date: Jul 17, 2021

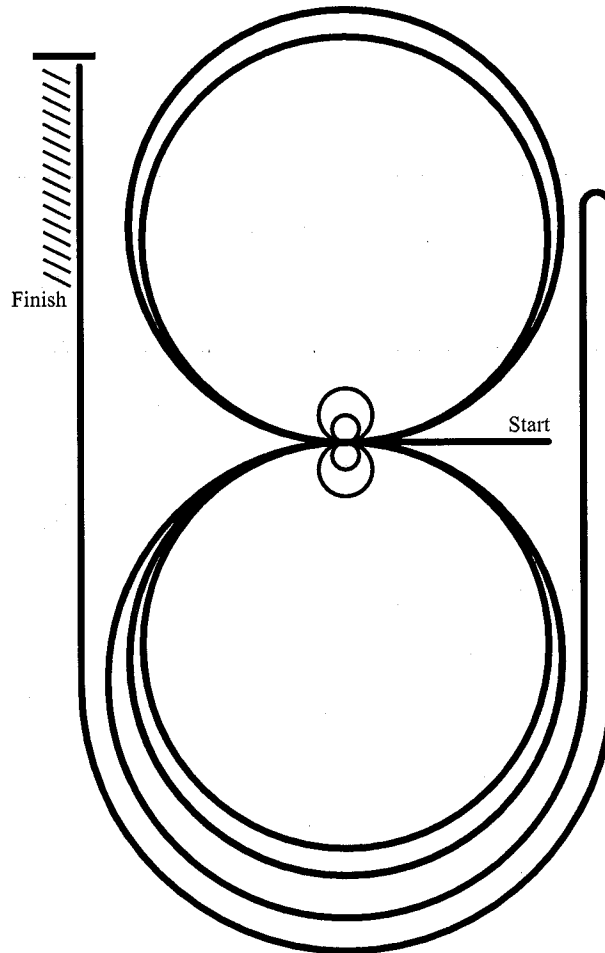

Pattern design by NULL

Horse may walk or jog to the center. Horses must stop prior to starting the pattern. Beginning at tl

1. Beginning on the left lead, complete two circles to the left. Stop at the center of the arena. Hesitate.
2. Complete two spins to the left. Hesitate.
3. Beginning on the right lead, complete two circles to the right. Stop at the center of the arena. Hesitate.
4. Complete two spins to the right. Hesitate.
5. Beginning on the left lead, go around the end of the arena, run down the right side of the arena past the center
6. Continue around the end of the arena to run down the left side past the center marker. Stop and back. Hesitate

Sunday's Patterns

Showmanship

Age Divisions

22. Amateur W-T (WALK Only)

23. Youth W-T 5-10

24. Youth W-T 11-18

Show: IPHC Fun In The Sun

Date: Jul 18, 2021

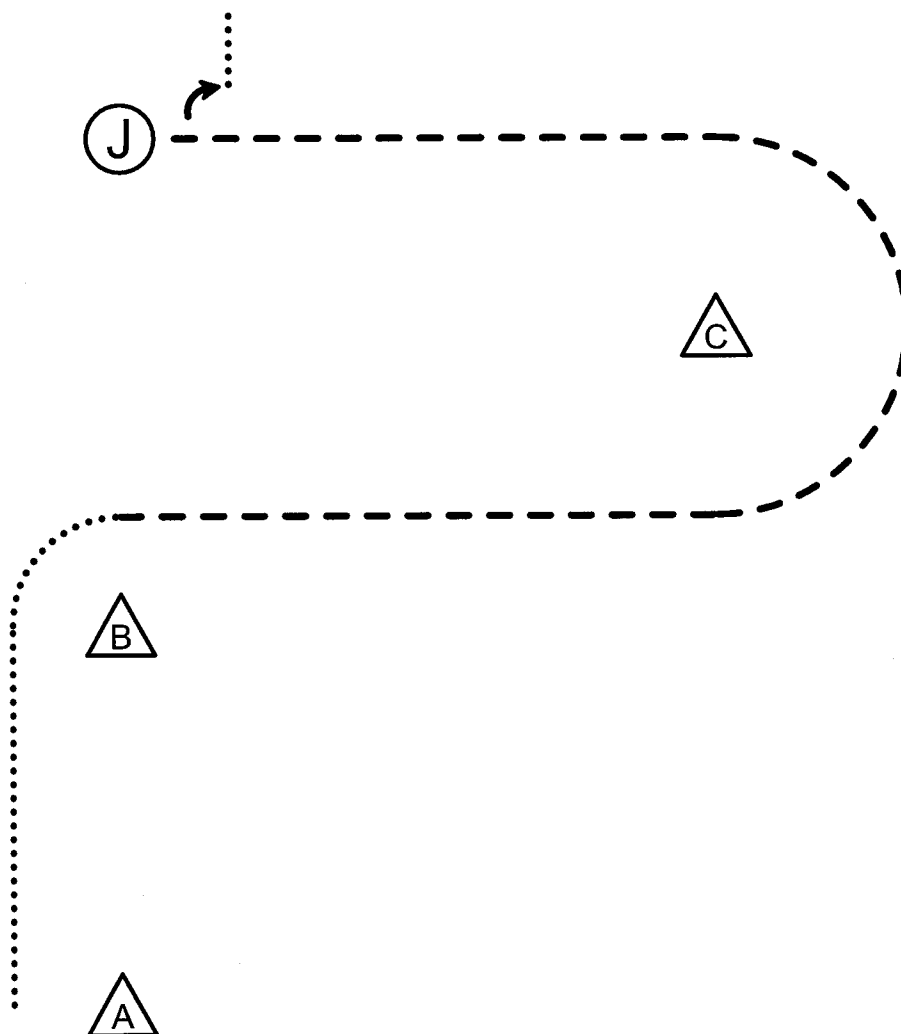

Be ready at A

1. Walk to and around B
2. Trot from B around C and to judge
3. Stop and set up for inspection
4. When dismissed, perform a 90° turn
5. Walk to exit

Follow the instructions of your ring steward

*Generated from Equiscribe for iOS
Scan the code to see your results as they are posted*

Showmanship

Age Divisions

- 25. Novice Youth
- 26. Youth 13 & Under
- 27. Youth 18 & Under
- 28. Novice Amateur
- 29. Amateur
- 30. Amateur SPB

Show: IPHC Fun In The Sun

Date: Jul 18, 2021

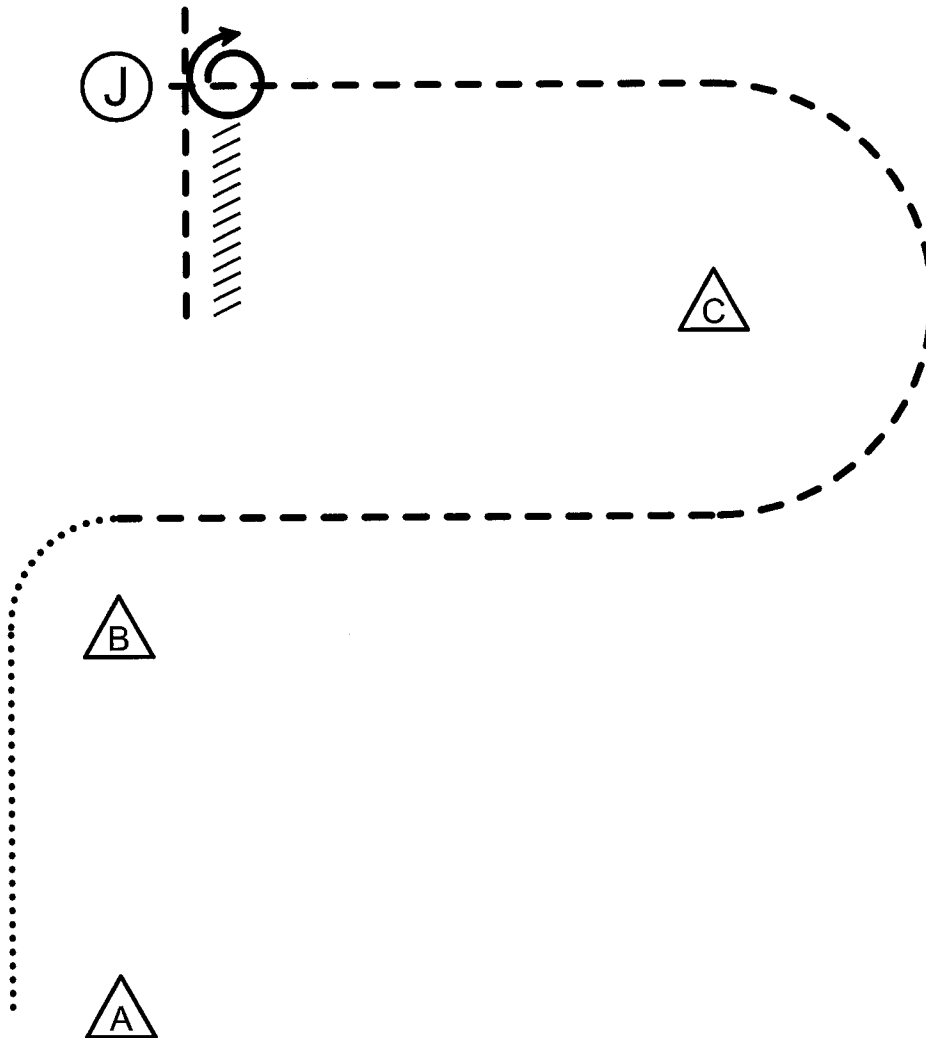

Be ready at A

1. Walk to and around B
2. Trot from B around C to the judge
3. Stop and set up for inspection
4. When dismissed, perform a 450° turn and back until even with C
5. Trot to the line-up

Follow the instructions of your ring steward

*Generated from Equiscribe for iOS
Scan the code to see your results as they are posted*

English Equitation

Age Divisions

85. Youth W-T 5-10

86. Amateur W-T

Show: IPHC Fun In The Sun

Date: Jul 18, 2021

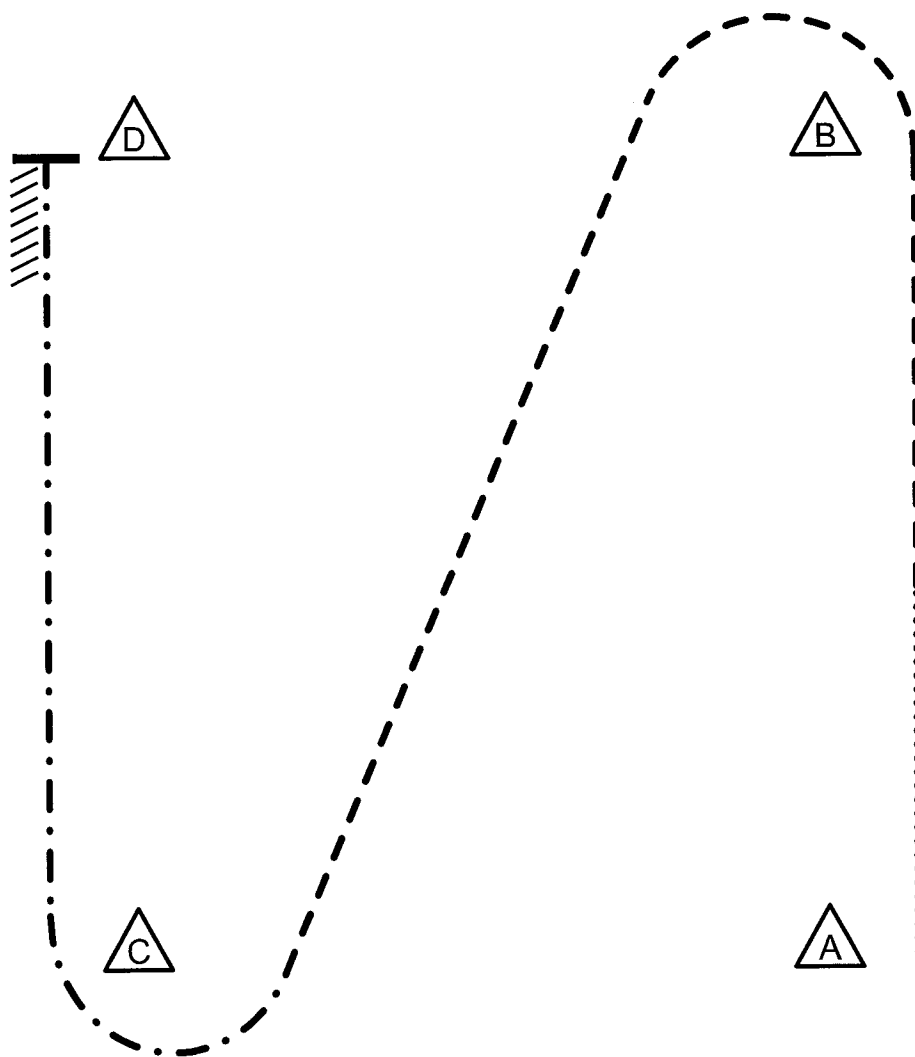

Be ready at cone A

1. Walk halfway to B, then posting trot on right diagonal around B to C
2. At C, sitting trot to D
3. Stop at D
4. Back 5 steps

English Equitation

Age Divisions

Show: IPHC Fun In The Sun
Date: Jul 18, 2021

95. Novice Youth
96. Youth 13 & Under
97. Youth 18 & Under
98. Novice Amateur
99. Amateur

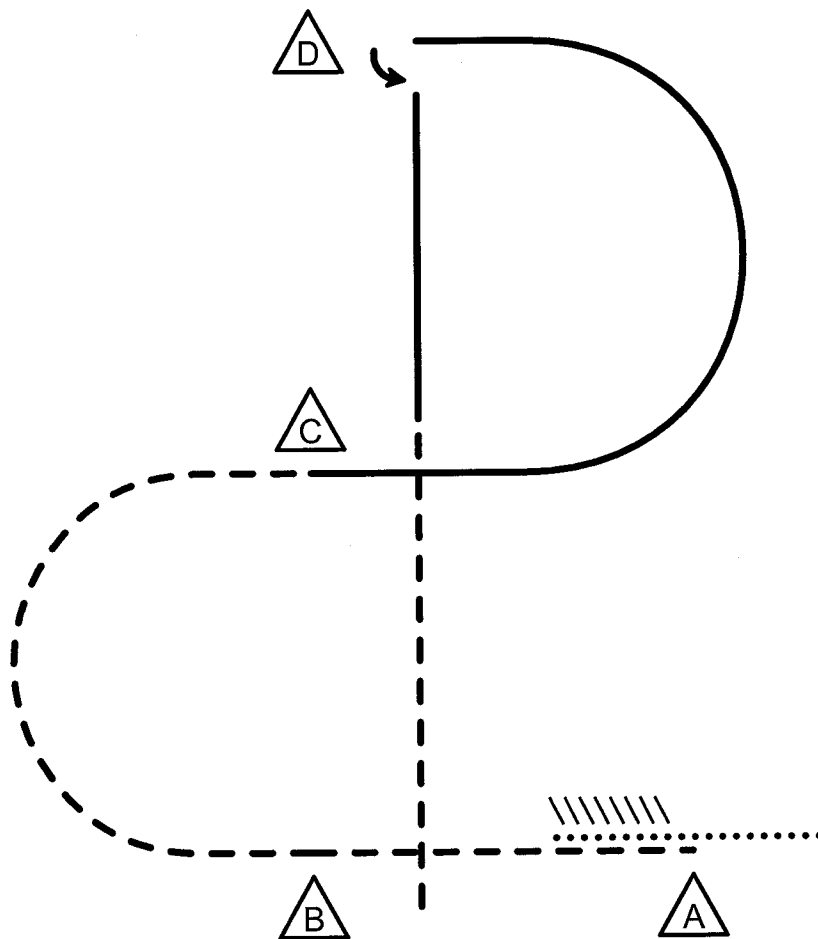

1. Walk past A; Halt and back to A
2. Posting trot on the right diagonal to B
3. At B, change diagonals and trot to C
4. At C, canter left lead to D
5. At D, halt and execute 90° turn on the forehand to left
6. Canter right lead to C
7. At C break to sitting trot; Pattern complete when even with B

Horsemanship

Age Divisions

105. Youth W-T 5-10

106. Amateur W-T

107. Youth W-T 11-18

Show: IPHC Fun In The Sun

Date: Jul 18, 2021

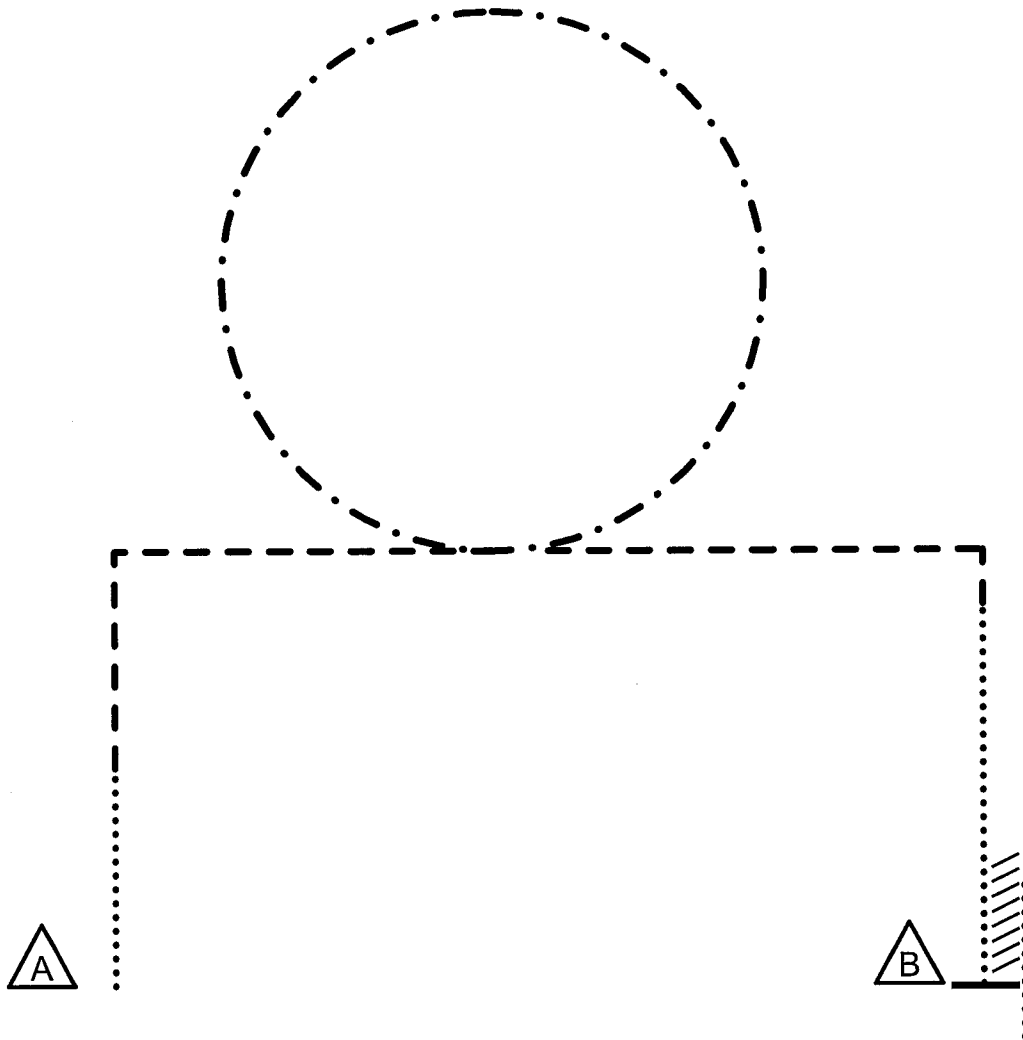

Be ready at A

1. Walk 1/2 the line then jog and turn corner and continue to middle
2. Extended trot circle to the left
3. Close the circle and resume a regular jog
4. Jog around the corner and then walk to cone B
5. Stop and back two horse lengths and walk out

Horsemanship

Age Divisions

Show: IPHC Fun In The Sun

Date: Jul 18, 2021

117. Novice Youth

118. Youth 13 & Under

119. Youth 18 & Under

120. Novice Amateur

121. Amateur

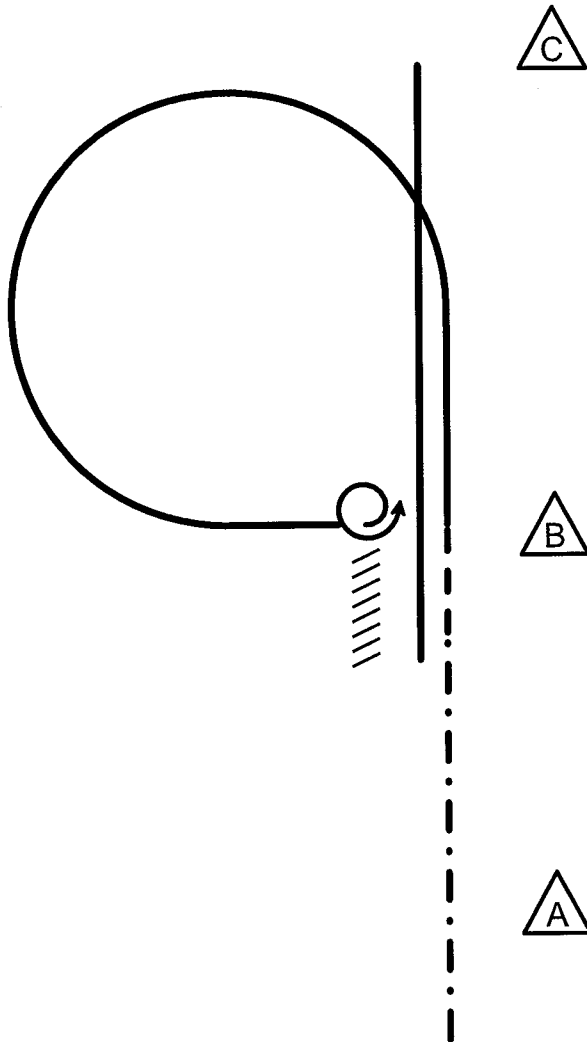

Pattern design by NULL

Begin before A

1. Pass A at an extended trot
2. Slow to a jog before reaching B
3. At B, lope on the left lead and circle at B as shown. Stop facing B
4. Turn 45° left
5. Back one horse length
6. Lope right lead to C. Stop at C

Trail

Age Divisions

127. Yearling In-hand

128. Amateur W-T

129. Youth W-T 5-10

Show: IPHC Fun In The Sun

Date: Jul 18, 2021

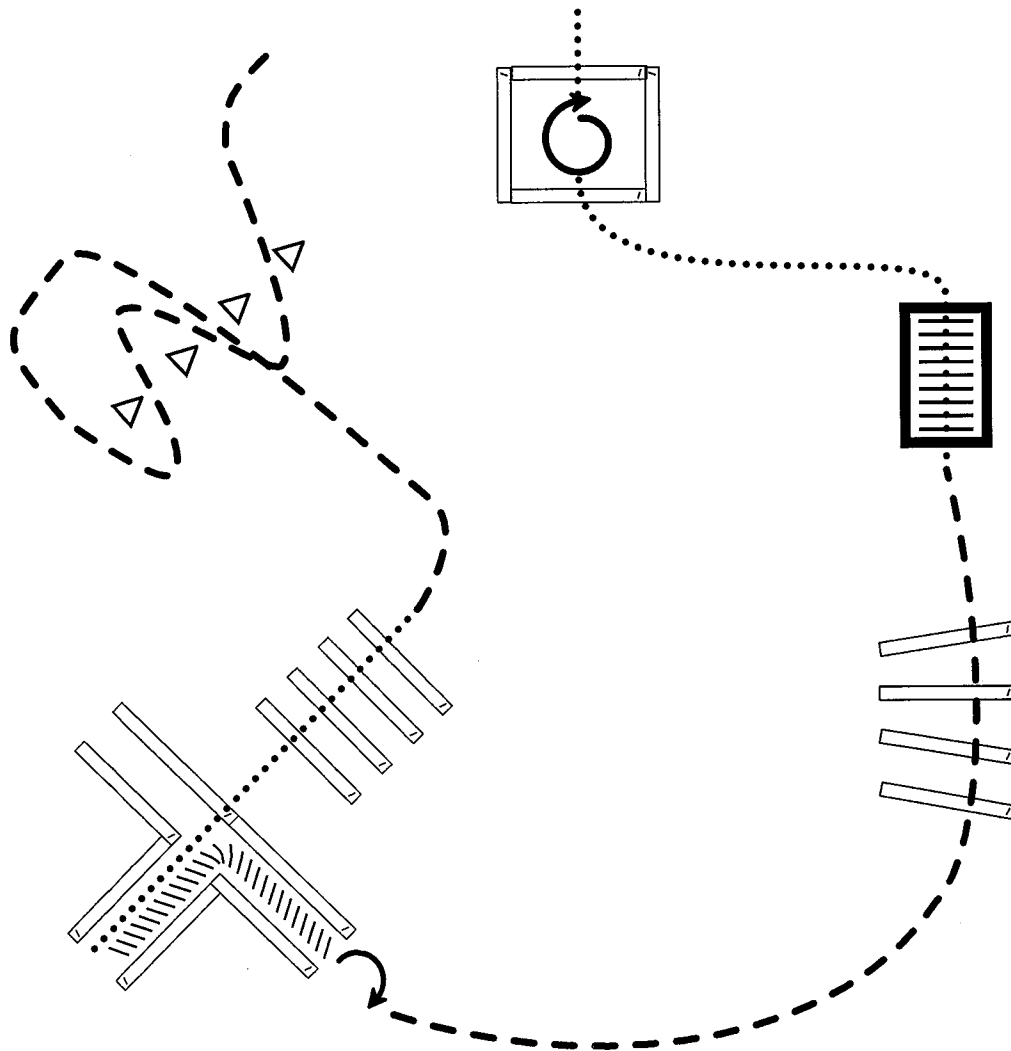

1. Jog through cones as shown
2. Walk over poles and into chute
3. Back out of chute, turn 180° right
4. Jog over poles to bridge
5. Walk over bridge
6. Walk into box and perform a 360° turn to the right
7. Walk out of box to finish

Trail

Age Divisions

- 130. Novice Youth
- 131. Youth 18 & Under
- 132. Green
- 133. Novice Amateur
- 134. Amateur
- 135. Open

Show: IPHC Fun In The Sun

Date: Jul 18, 2021

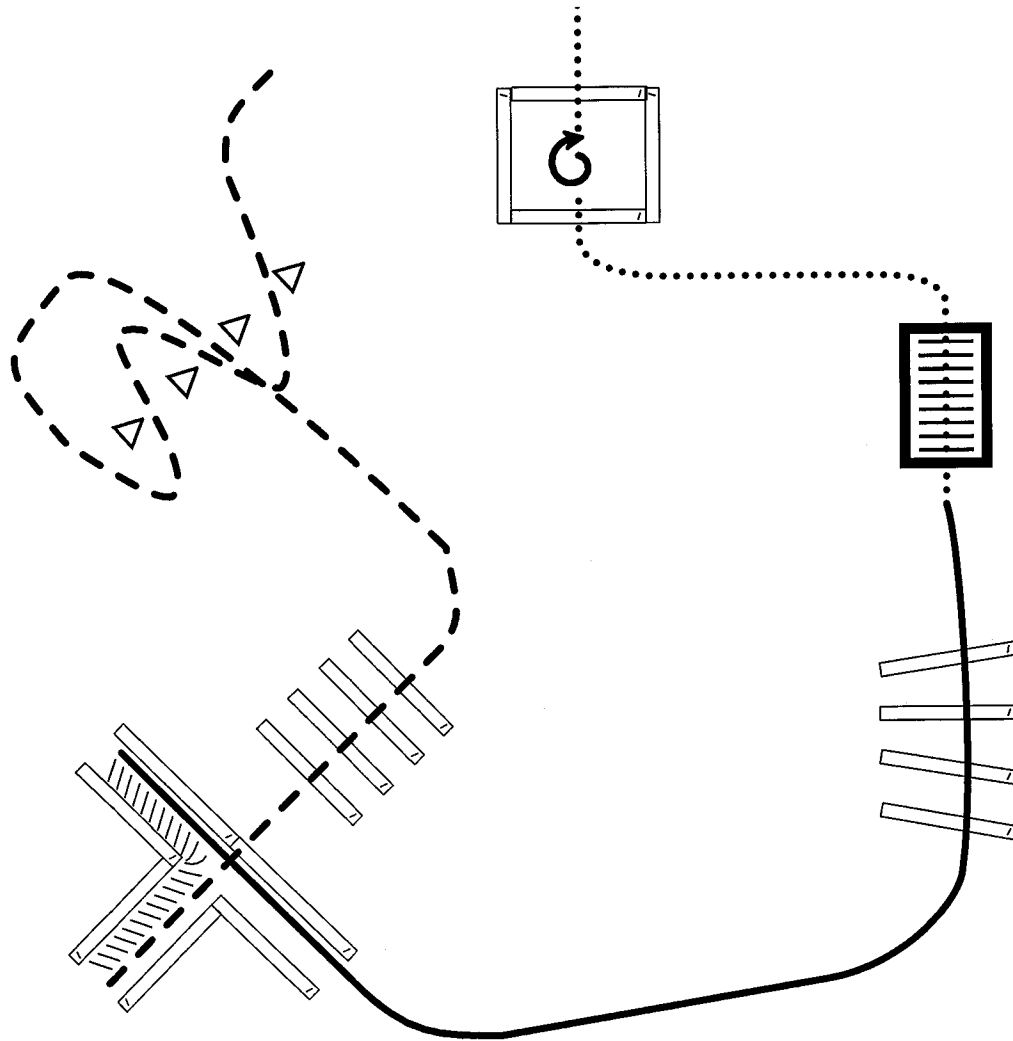

1. Jog through cones as shown
2. Jog over poles and into chute
3. Back the L
4. Lope on the left lead over poles to bridge
5. Walk over bridge
6. Walk into box and perform a 360° turn to the right
7. Walk out of box to finish

Western Riding

Age Divisions

122. Youth 18 & Under

125. Amateur

126. Open

Show: IPHC Fun In The Sun

Date: Jul 18, 2021

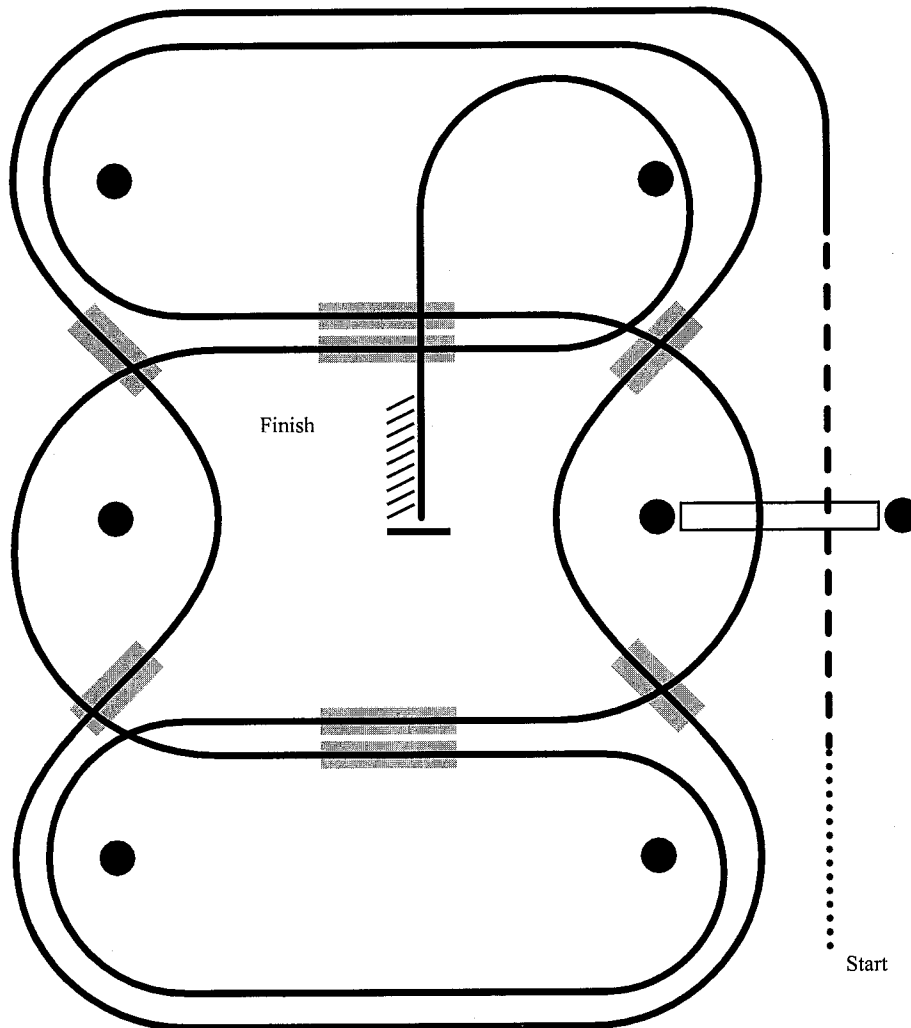

1. Walk, transition to jog, jog over log
2. Transition to the lope, on the left lead
3. First line change
4. Second line change
5. Third line change
6. Fourth line change
7. First crossing change
8. Lope over log
9. Second crossing change
10. Third crossing change
11. Fourth crossing change
12. Lope, stop & back

Generated from Equiscribe for iOS
Scan the code to see your results as they are posted

Western Riding

Age Divisions

123. Green

124. Novice Amateur

Show: IPHC Fun In The Sun

Date: Jul 18, 2021

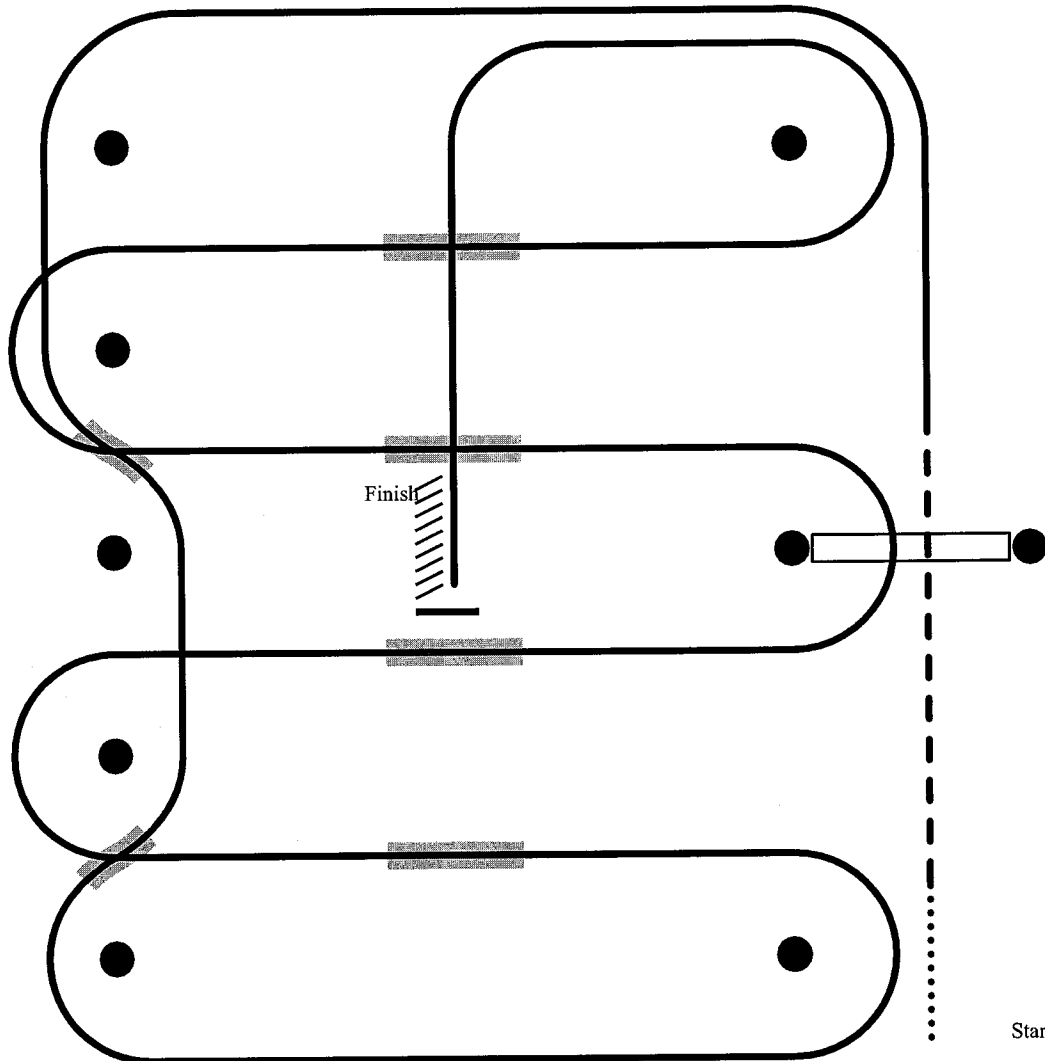

1. Walk at least 15' & jog over log
2. Transition to left lead & lope around end
3. First line change
4. Second line change lope around end of arena
5. First crossing change
6. Second crossing change
7. Lope over log
8. Third crossing change
9. Fourth crossing change
10. Lope up the center, stop & back

*Generated from Equiscribe for iOS
Scan the code to see your results as they are posted*

Ranch Riding

Age Divisions

136. Youth 18 & Under

137. Amateur

138. Open

Show: IPHC Fun In The Sun

Date: Jul 18, 2021

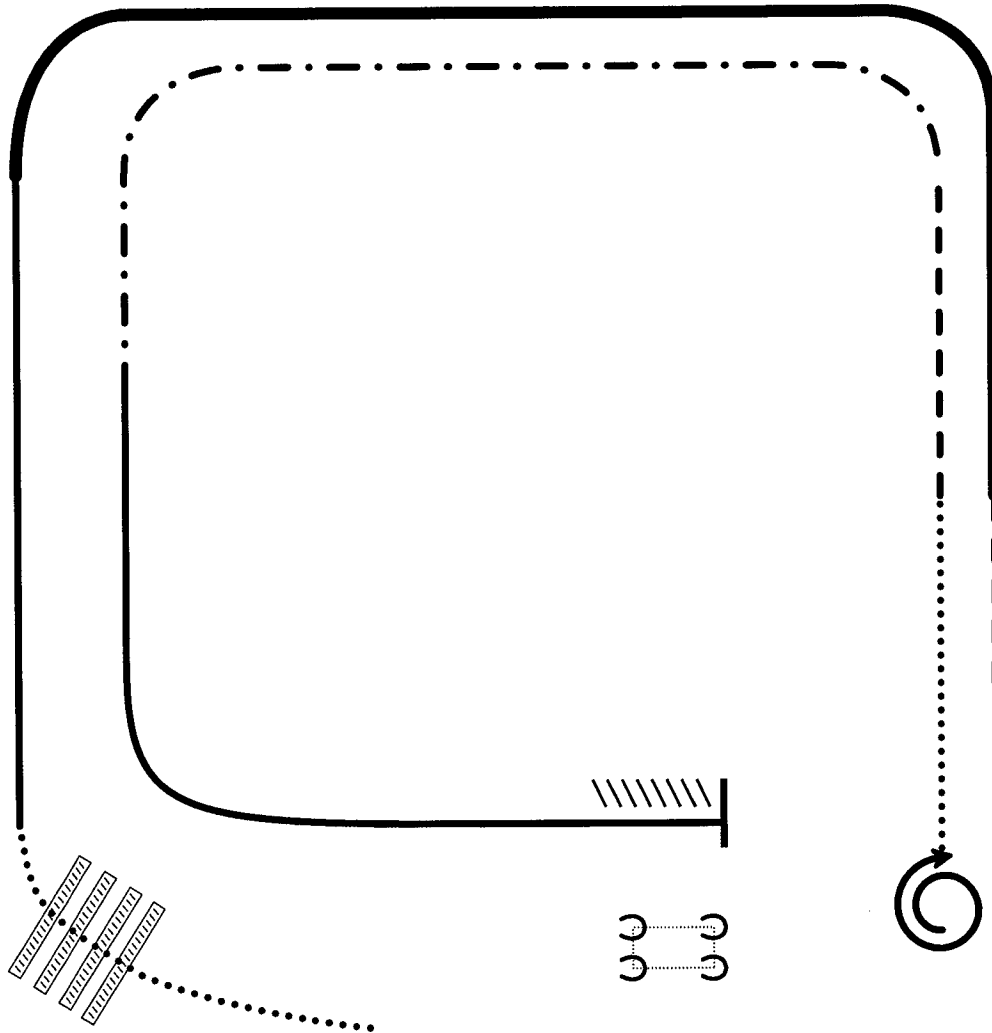

1. Walk
2. Walk over logs
3. Lope right lead
4. Extended lope (right lead)
5. Trot
6. Stop, 1 1/2 turns right
7. Walk
8. Trot
9. Extended trot
10. Lope left lead
11. Stop and back
12. Side pass right

Reining

Age Divisions

139. Youth 18 & Under

140. Amateur

141. Open

Show: IPHC Fun In The Sun

Date: Jul 18, 2021

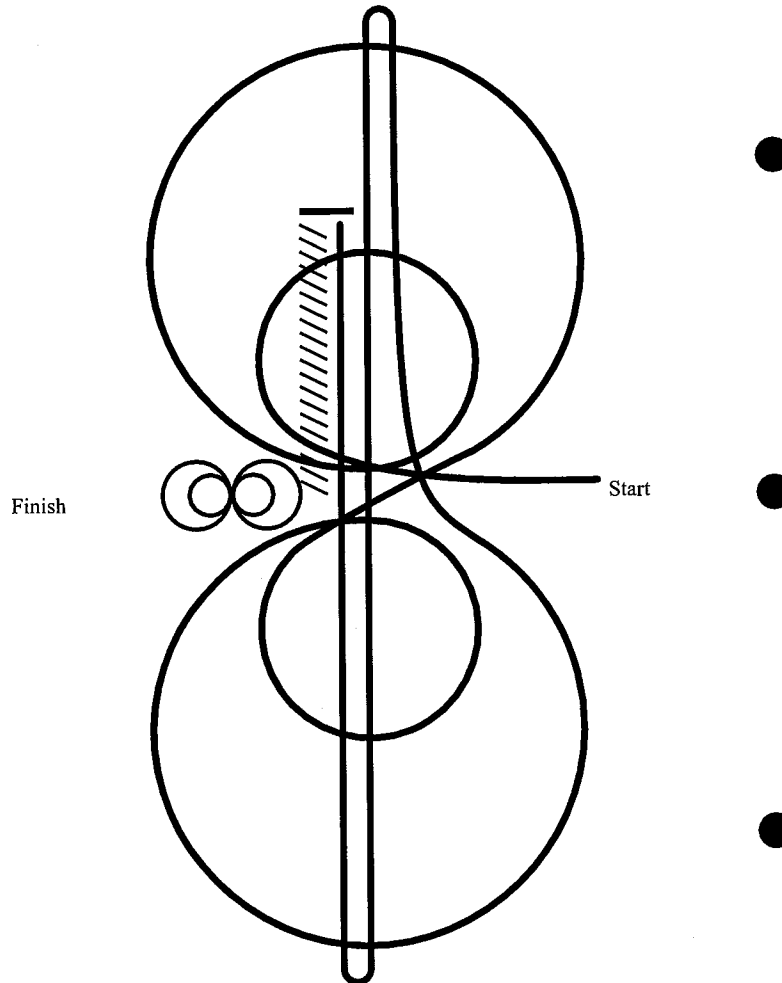

1. Beginning on the right lead, complete two circles to the right: the first small and slow; the second large and fast
2. Change leads at the center of the arena
3. Complete two circles to the left: the first small and slow; the second large and fast
4. Change leads at the center of the arena
5. Run to the far end of the arena, past end marker, and do left rollback -- no hesitation
6. Run to the opposite end of the arena, past end marker and do a right rollback -- no hesitation
7. Run past the center marker and do a sliding stop. Back up to the center of the arena (or at least 10ft). Hesitate
8. Complete two spins to the right
9. Complete two spins to the left
10. Hesitate to demonstrate completion of pattern
11. Walk to the judge and stop for inspection until dismissed

Generated from Equiscribe for iOS
Scan the code to see your results as they are posted