



**FALL FUTURITY
& P-O-R!
October 13-14, 2018
SAM both days**



Held at the beautiful Iowa Equestrian Center – eastern Iowa's premier show facility.

Kirkwood Community College
801 76th Ave Dr SW
Rapids, IA 52404

JUDGES

April Devitt (KY)
Clint Fullerton (MO)
Tom Crowley (MN)
Gayle Lampinen (MI)



**Pattern
Book: \$5.00**

IPHC Fall Show and Futurities

Showmanship (Walk/Trot 5-10 - Am Walk/Trot)

Show Date: Oct 13-14, 2018

WWW.HORSESHOWPATTERNS.COM

WWW.HORSESHOWPATTERNS.COM

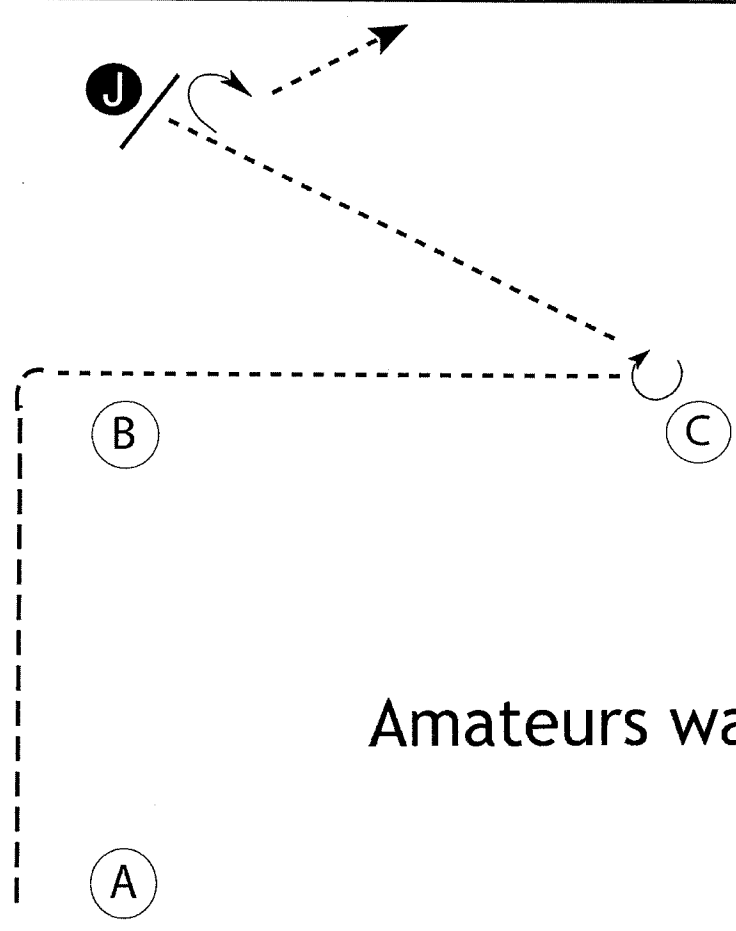

Amateurs walk only

Be ready at A.

1. Trot to B.
2. Walk to C.
3. Stop at C.
4. 5/8 turn at C.
5. Walk to judge and set up for inspection.
6. When dismissed 1/4 turn and walk off.

Walk	-----
Trot	- - - - -
Back	←
Marker	Ⓟ
Judge	Ⓝ

[S/WT-20]

Pattern Provided by:

IPHC Fall Show and Futurities

Showmanship (Novice Youth - Novice Amateur - 13 & Under)

Show Date: Oct 13-14, 2018

WWW.HORSESHOWPATTERNS.COM

WWW.HORSESHOWPATTERNS.COM

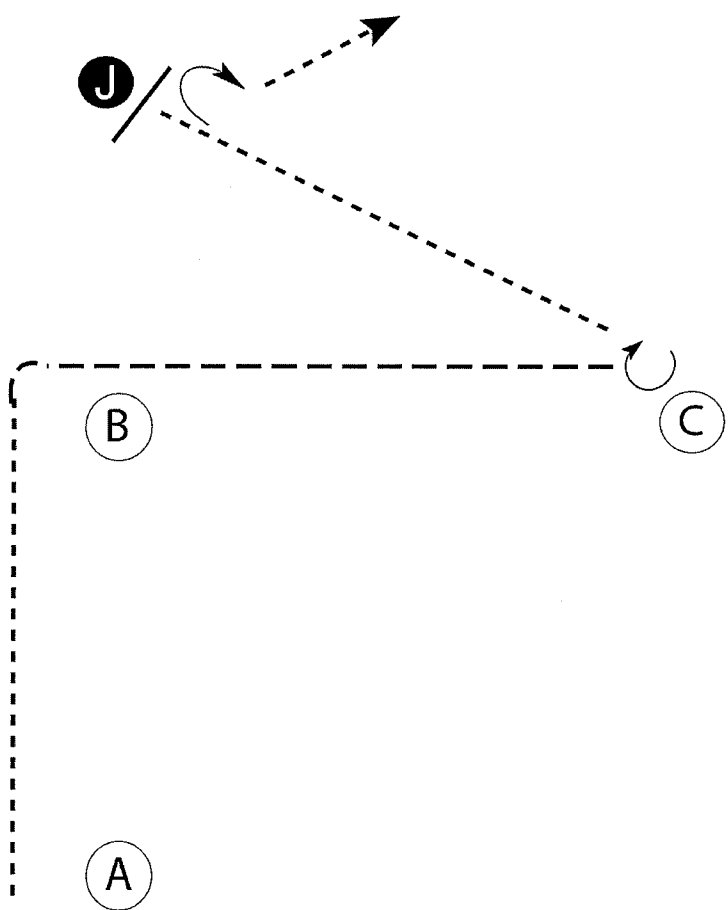

Be ready at A.

1. Walk to B.
2. Trot to C.
3. Stop at C.
4. 5/8 turn at C.
5. Walk to judge and set up for inspection.
6. When dismissed 1/4 turn and walk off.

- Walk - - - - -
- Trot - - - - -
- Back ← - - - - -
- Marker (B)
- Judge (J)

[S/1-20]

Pattern Provided by:

IPHC Fall Show and Futurities

Showmanship (Youth 18 & Under - Amateur - SPB)

Show Date: Oct 13-14, 2018

WWW.HORSESHOWPATTERNS.COM

WWW.HORSESHOWPATTERNS.COM

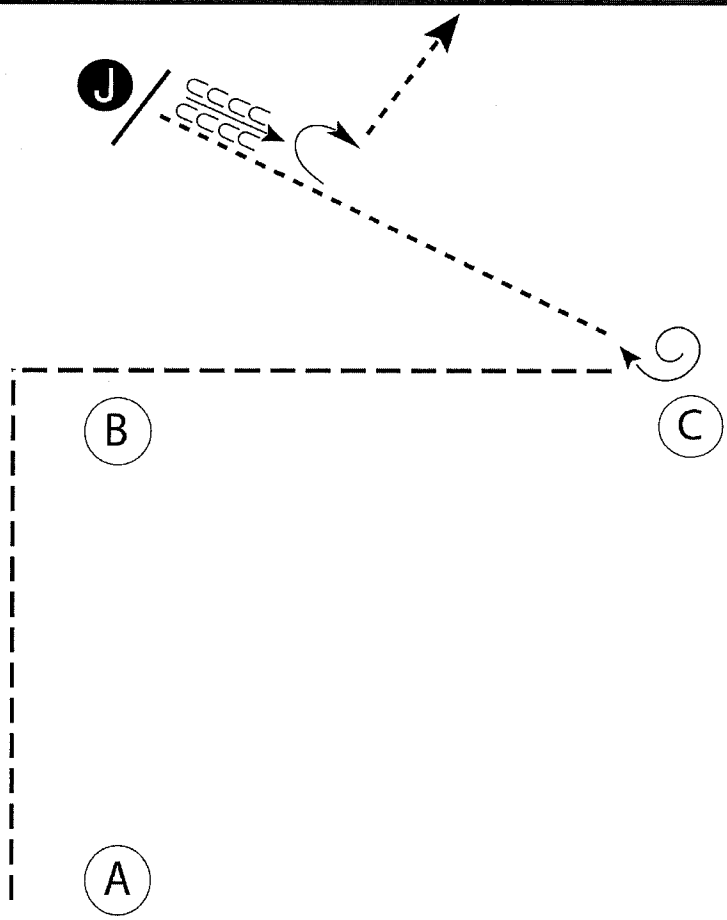

Be ready at A.

1. Trot to B.
2. Trot the corner at B and continue to trot to C.
3. Stop at C.
4. 1 5/8 turn at C.
5. Walk to judge and set up for inspection.
6. When dismissed, back one horse length.
7. 1/4 turn and walk off.

Walk -----
Trot -----
Back ← [Backward Trot Symbols]
Marker (B)
Judge (J)

[S/2-20]

Pattern Provided by:

Iowa Paint Horse Show

Walk Trot Hunt Seat Equitation (Youth/Amateur Walk Trot)

Show Date: Octobe 13-14 /2018

W W W . H O R S E S H O W P A T T E R N S . C O M

W W W . H O R S E S H O W P A T T E R N S . C O M

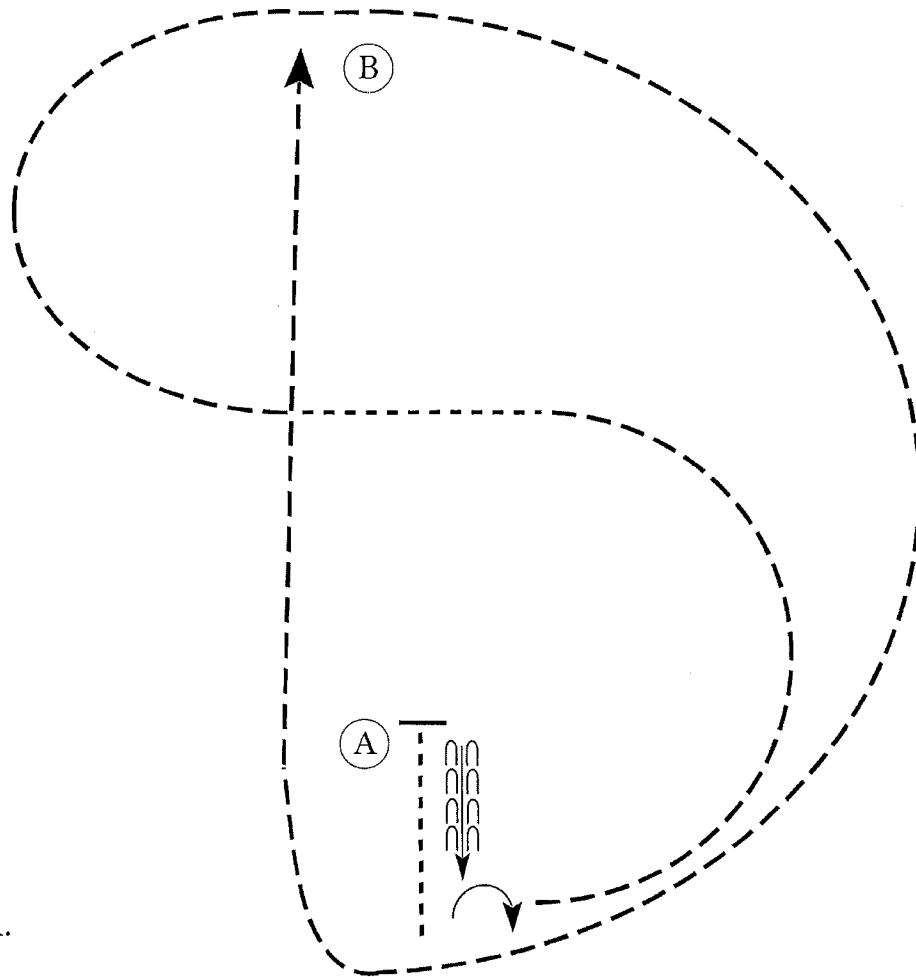

Be ready before A.

1. Walk to A, stop and back approximately one horse length.
2. Perform a 90 degree forehand turn right.
3. Trot on the right diagonal in a half circle to center of pattern.
4. Walk 2-3 horse lengths.
5. Sitting trot in a half circle to B.
6. Trot on the left diagonal to and around A.
7. Continue to trot on the left diagonal to B.

Pattern is over once you pass B.

Walk	-----
Trot	- - - - -
Extended Trot	-----
Canter	-----
Leg Yield	
Lead Change	↘
Back	←←←←←
Marker	Ⓚ
Sidepass	←-----←
Hand Gallop	-----

[HSE/WT-67]

Pattern Provided by:

Iowa Paint Horse Show

Hunt Seat Equitation (Novice Youth/Amateur)

Show Date: Octobe 13-14 /2018

W W W . H O R S E S H O W P A T T E R N S . C O M

W W W . H O R S E S H O W P A T T E R N S . C O M

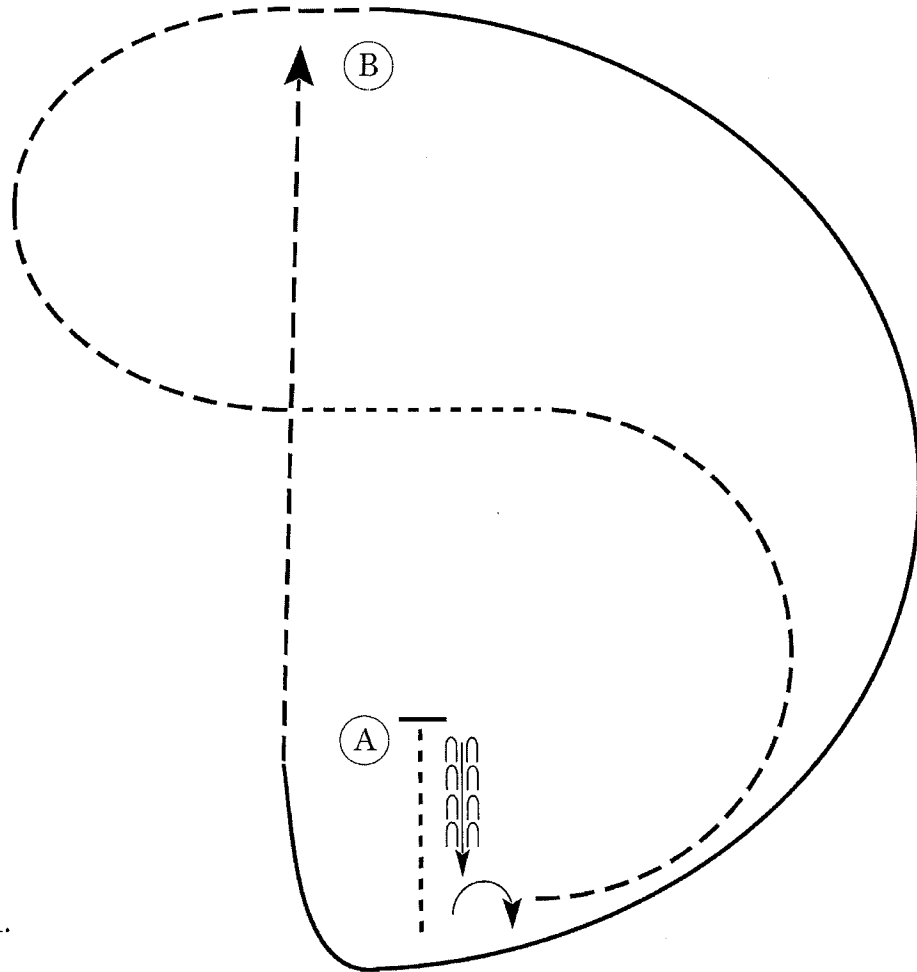

Be ready before A.

1. Walk to A, stop and back approximately one horse length.
2. Perform a 90 degree forehand turn right.
3. Trot on the right diagonal in a half circle to center of pattern.
4. Walk 2-3 horse lengths.
5. Sitting trot in a half circle to B.
6. Canter on the right lead to and around A.
7. Trot on the left diagonal to B.

Pattern is over once you pass B.

Walk	-----
Trot	- - - - -
Extended Trot	-----
Canter	-----
Leg Yield	
Lead Change	↘ ↙
Back	← ← ← ← ←
Marker	⊙ B
Sidepass	← - - - - ←
Hand Gallop	-----

[HSE/1-67]

Pattern Provided by:

Iowa Paint Horse Show

Hunt Seat Equitation (Youth/Amateur)

Show Date: Octobe 13-14 /2018

W W W . H O R S E S H O W P A T T E R N S . C O M

W W W . H O R S E S H O W P A T T E R N S . C O M

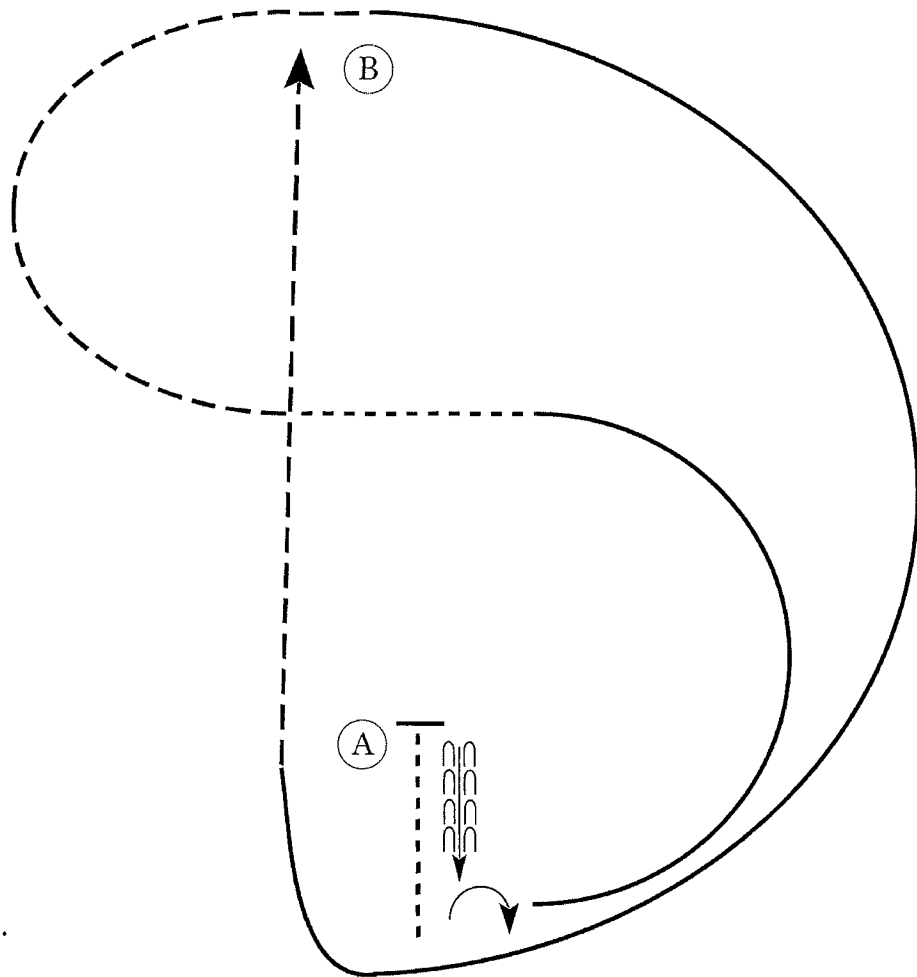

Be ready before A.

1. Walk to A, stop and back approximately one horse length.
2. Perform a 90 degree forehand turn right.
3. Canter on the left lead in a half circle to center of pattern.
4. Walk 2-3 horse lengths.
5. Sitting trot in a half circle to B.
6. Canter on the right lead to and around A.
7. Trot on the left diagonal to B.

Pattern is over once you pass B.

Walk	-----
Trot	- - - - -
Extended Trot	-----
Canter	-----
Leg Yield	
Lead Change	— / —
Back	← ← ← ← ←
Marker	⊙
Sidepass	← — — — — →
Hand Gallop	-----

[HSE/2-67]

Pattern Provided by:

IOWA PAINT HORSE CLUB

All Walk Trot/In Hand

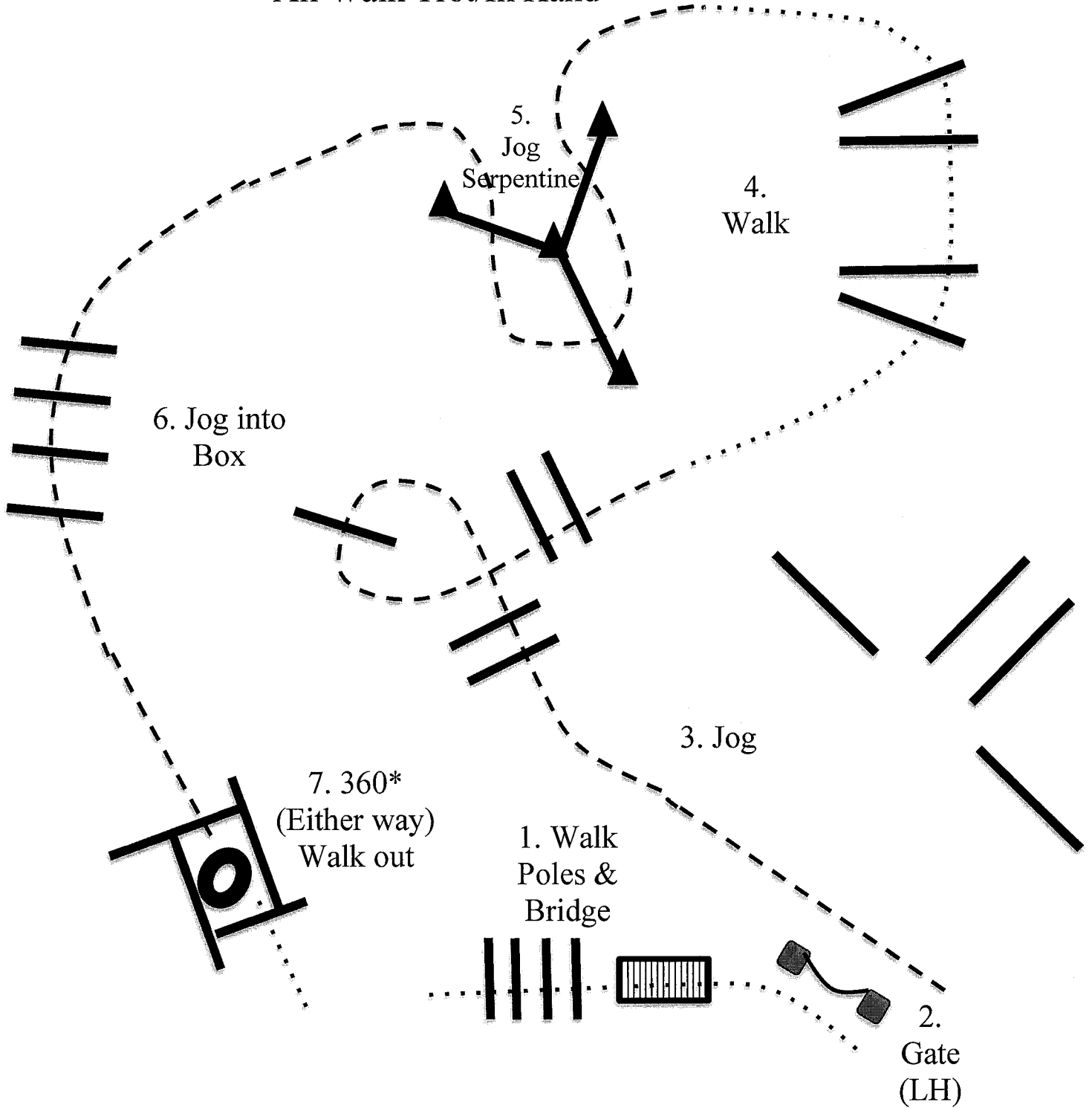

IOWA PAINT HORSE CLUB

All Trail except Walk Trot

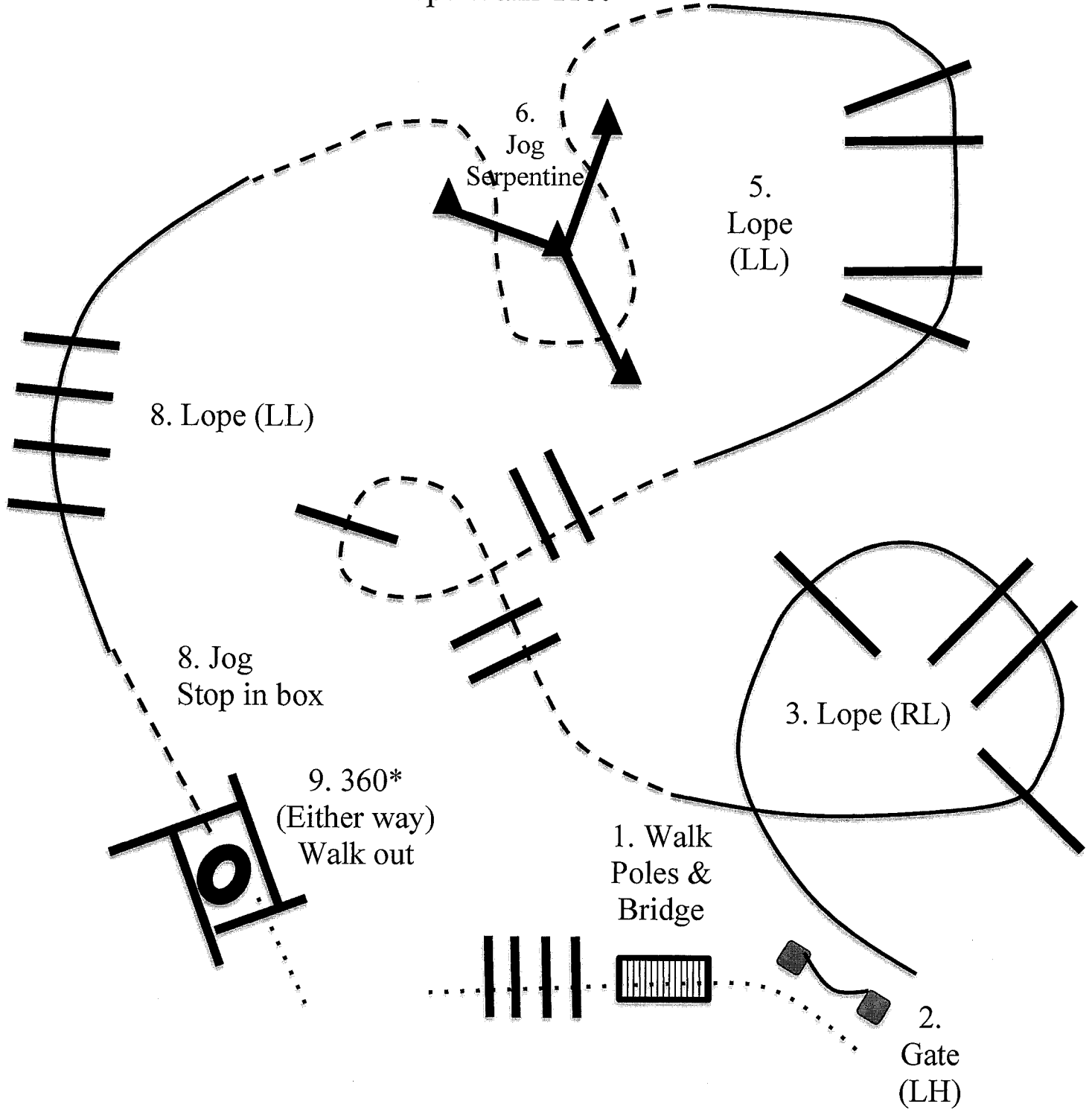

IPHC Fall Show and Futurities

Horsemanship (Walk/Trot)

Show Date: Oct 13-14, 2018

W W W . H O R S E S H O W P A T T E R N S . C O M

W W W . H O R S E S H O W P A T T E R N S . C O M

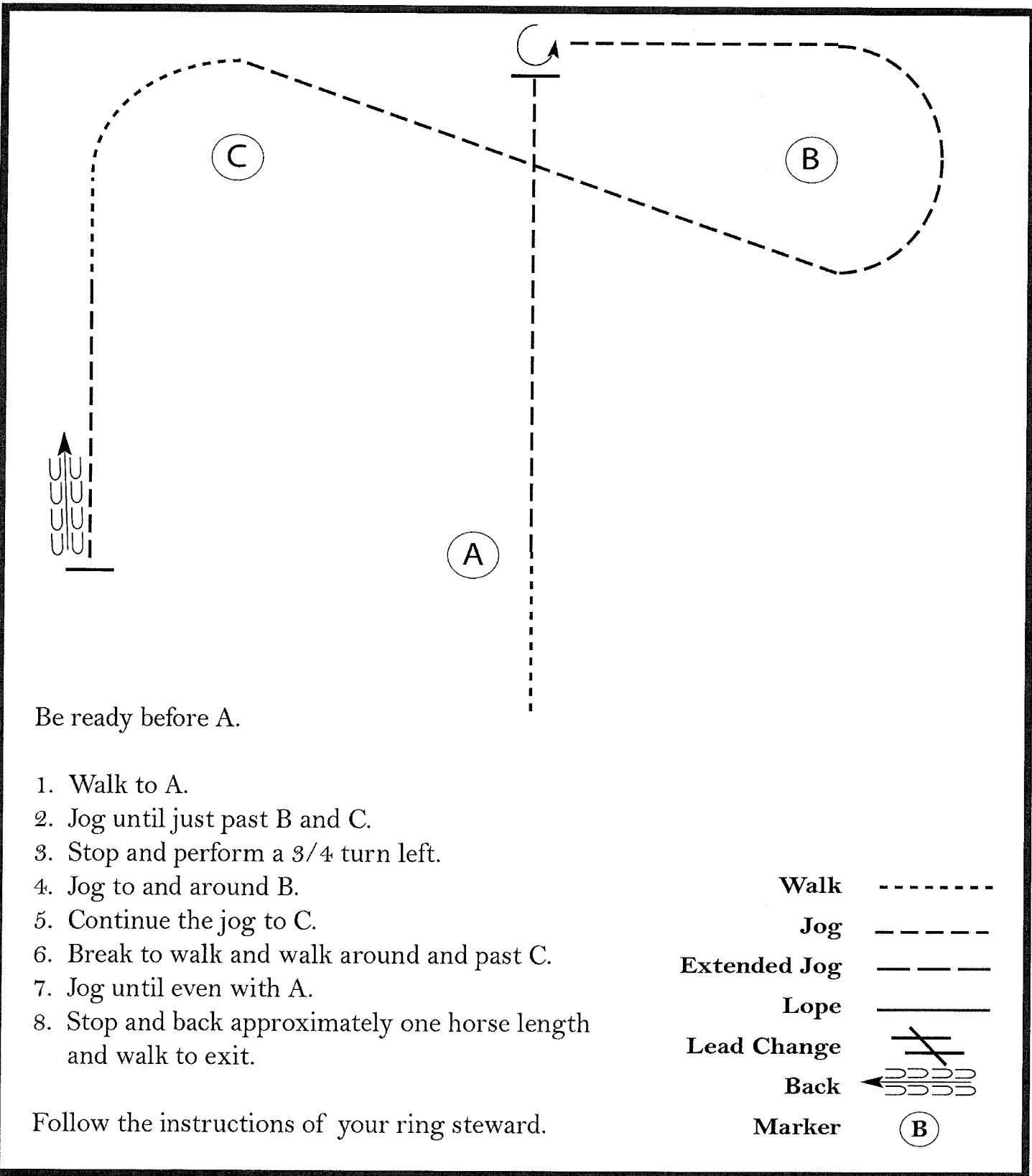

Be ready before A.

1. Walk to A.
2. Jog until just past B and C.
3. Stop and perform a 3/4 turn left.
4. Jog to and around B.
5. Continue the jog to C.
6. Break to walk and walk around and past C.
7. Jog until even with A.
8. Stop and back approximately one horse length and walk to exit.

Walk
Jog	- - - - -
Extended Jog	- - - - -
Lope	—————
Lead Change	
Back	
Marker	(B)

Follow the instructions of your ring steward.

[WH/WT-91]

Pattern Provided by:

IPHC Fall Show and Futurities

Horsemanship (Novice Youth - Novice Amateur - 13 & Under)

Show Date: Oct 13-14, 2018

W W W . H O R S E S H O W P A T T E R N S . C O M

W W W . H O R S E S H O W P A T T E R N S . C O M

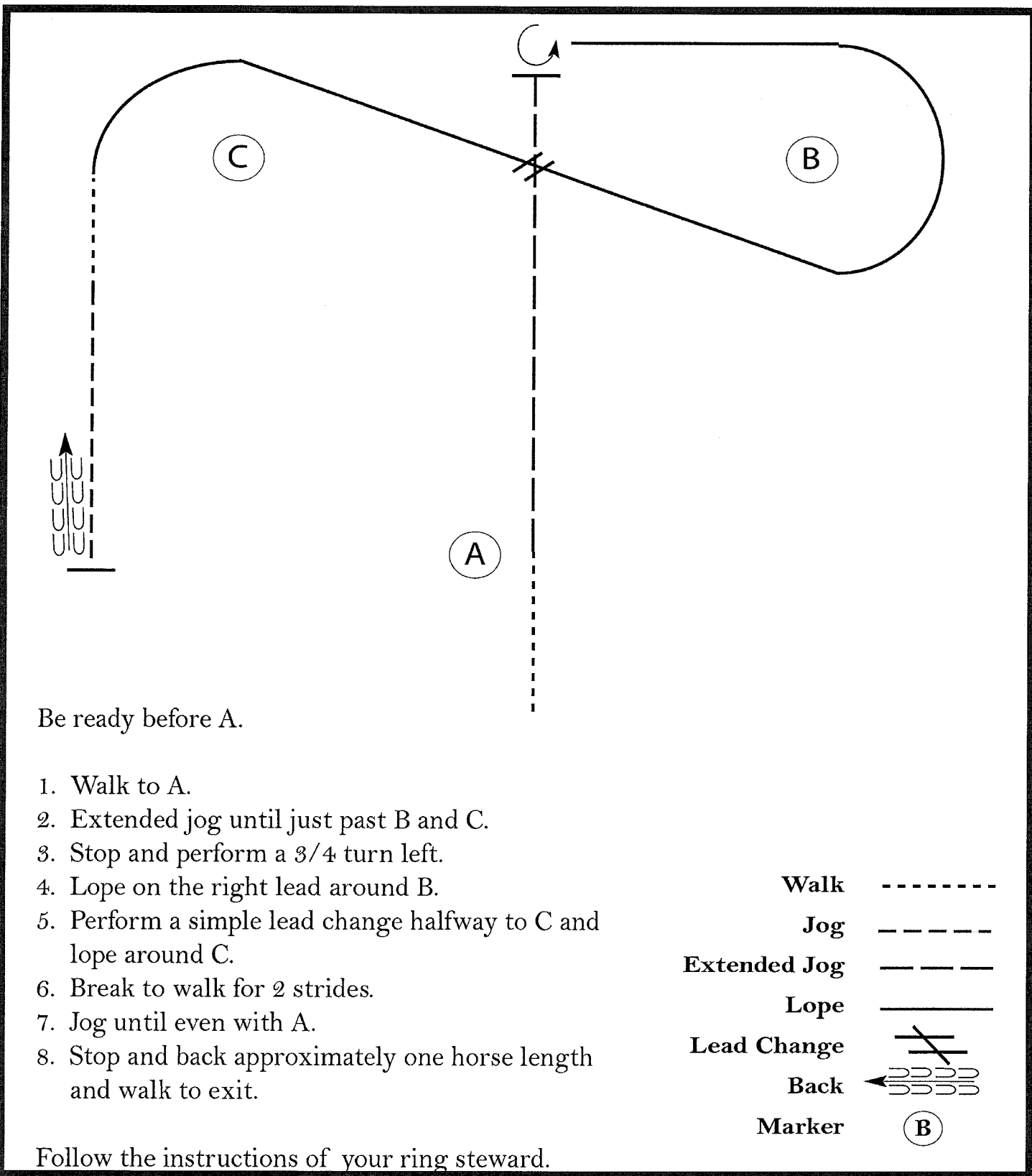

Be ready before A.

1. Walk to A.
2. Extended jog until just past B and C.
3. Stop and perform a 3/4 turn left.
4. Lope on the right lead around B.
5. Perform a simple lead change halfway to C and lope around C.
6. Break to walk for 2 strides.
7. Jog until even with A.
8. Stop and back approximately one horse length and walk to exit.

Walk	-----
Jog	- - - - -
Extended Jog	- - - - -
Lope	—————
Lead Change	⋈
Back	← — — — —
Marker	Ⓚ

Follow the instructions of your ring steward.

[WH/2-91]

Pattern Provided by:

IPHC Fall Show and Futurities

Horsemanship (Youth 18 & Under- Amateur - SPB)

Show Date: Oct 13-14, 2018

WWW.HORSESHOWPATTERNS.COM

WWW.HORSESHOWPATTERNS.COM

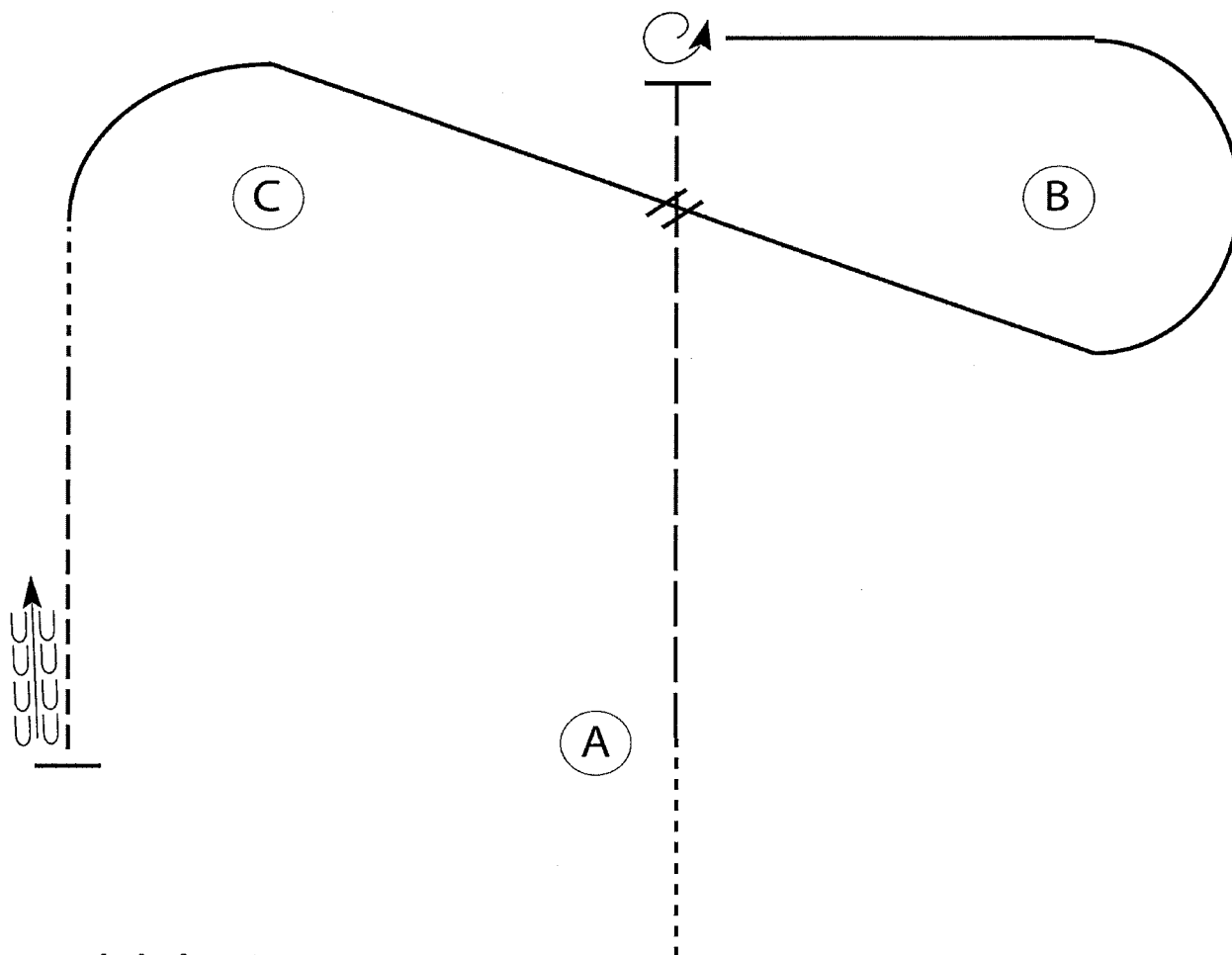

Be ready before A.

1. Walk to A.
2. Extended jog until just past B and C.
3. Stop and perform a 1 3/4 turn left.
4. Lope on the right lead around B.
5. Change leads halfway to C and lope around C.
6. Break to walk for 2 strides.
7. Jog until even with A.
8. Stop and back approximately one horse length and walk to exit.

Walk	-----
Jog	- - - - -
Extended Jog	-----
Lope	
Lead Change	⋈
Back	←←←←←
Marker	Ⓚ

Follow the instructions of your ring steward.

[WH/3-91]

Pattern Provided by:

Western Riding Youth, Amateur, Open

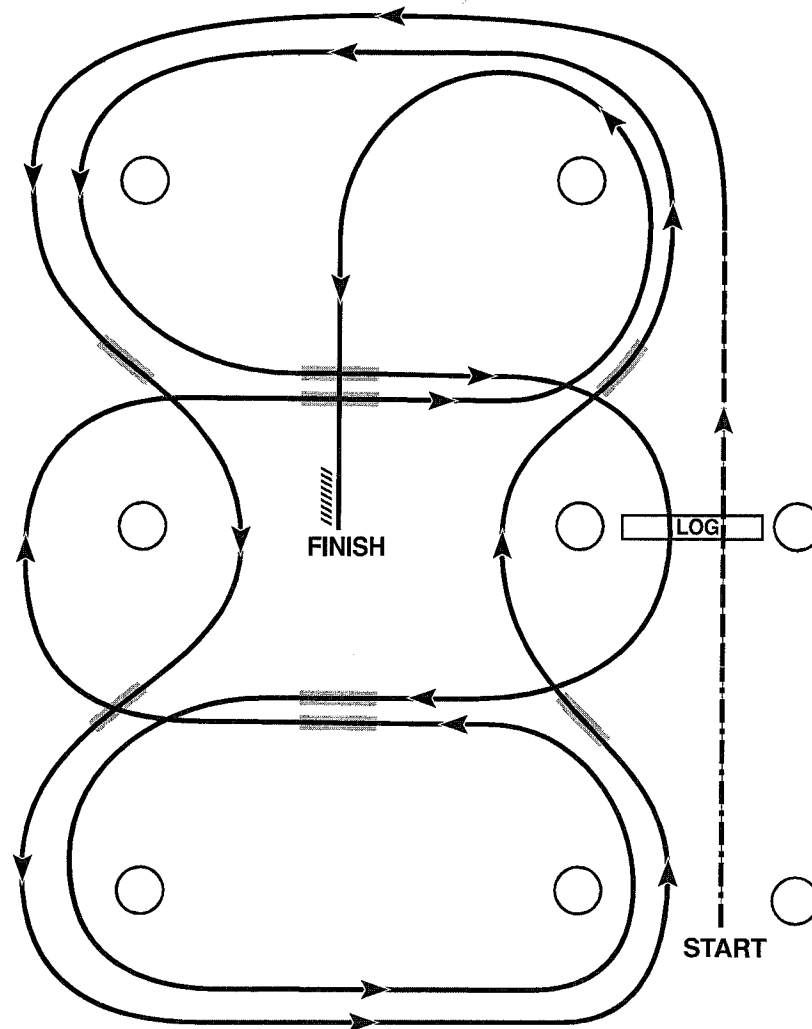

Recommended for small arenas.

1. Walk, transition to jog, jog over log.
2. Transition to the lope, on the left lead.
3. First line change.
4. Second line change.
5. Third line change.
6. Fourth line change.
7. First crossing change.
8. Lope over log.
9. Second crossing change.
10. Third crossing change.
11. Fourth crossing change.
12. Lope, stop and back.

Western Riding Green and Novice

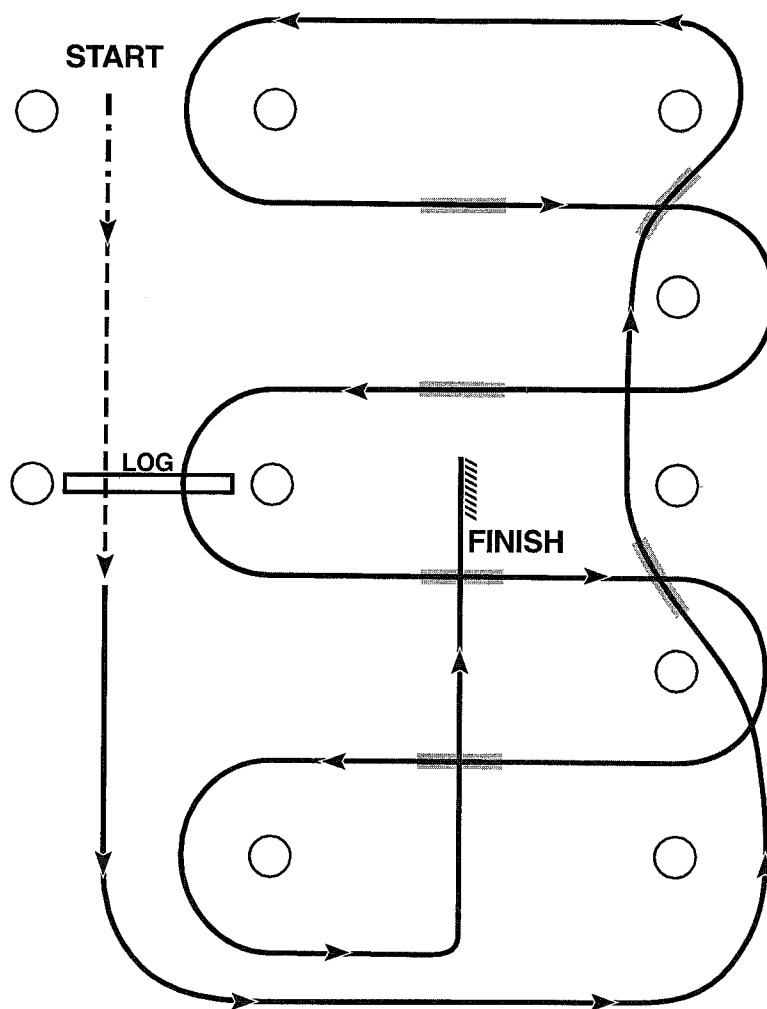

1. Walk at least 15' and jog over log.
2. Transition to left lead and lope around end.
3. First line change.
4. Second line change log around end of arena
5. First crossing change.
6. Second crossing change.
7. Lope over log.
8. Third crossing change.
9. Fourth crossing change.
10. Lope up the center, stop and back.

Iowa Paint Horse Show

Ranch Riding (All Classes)

Show Date: Octobe 13-14 /2018

www.horsethows.com

www.horsethows.com

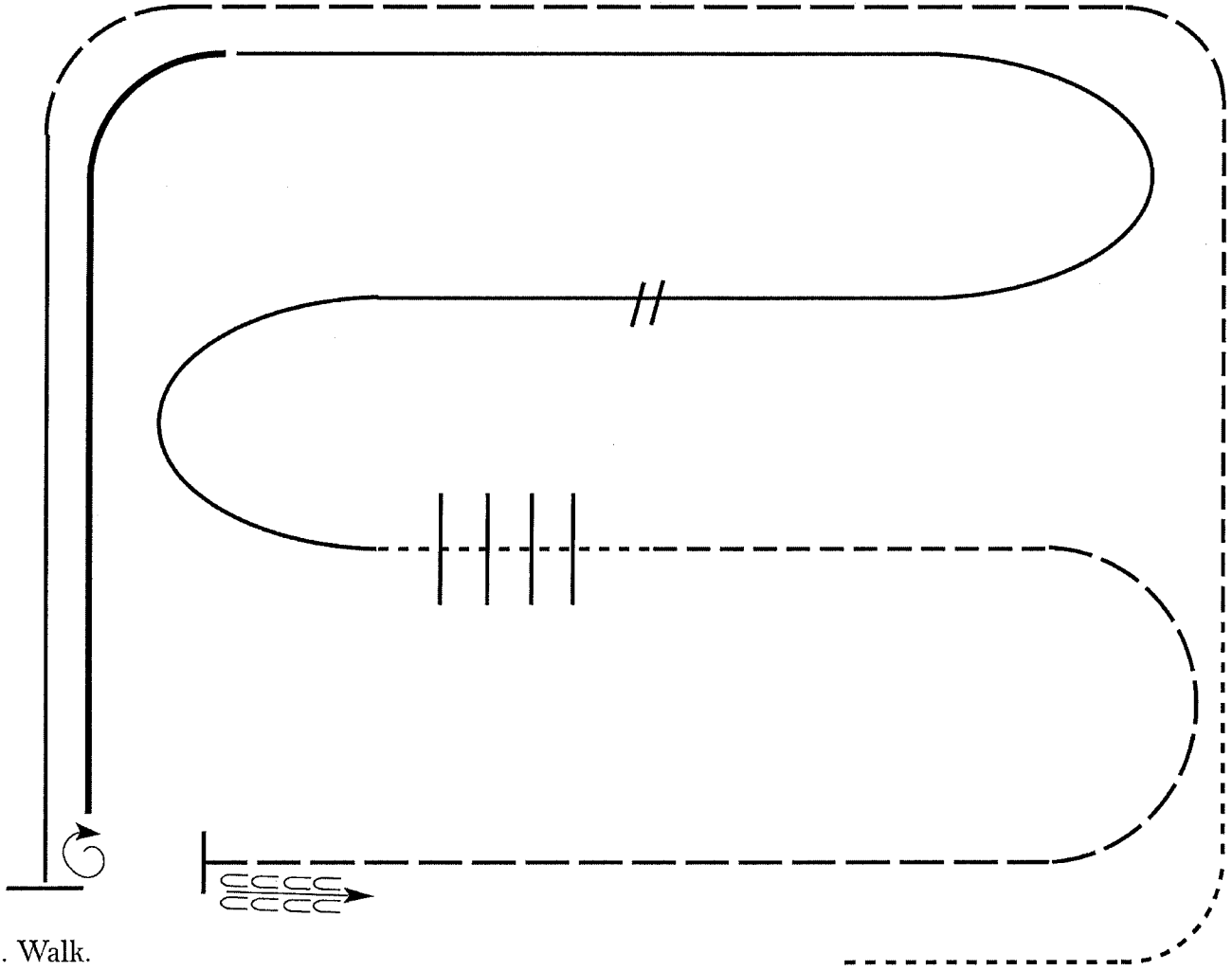

1. Walk.
2. Trot
3. Extended trot.
4. Left lead lope
5. Stop, 1 1/2 turn right
6. Extended lope
7. Collect to working lope-right lead
8. Change leads (simple or flying)
9. Walk
10. Walk over logs
11. Trot
12. Extended trot
13. Stop and back

Walk	
Jog	
Extended Jog	
Lope	
Lead Change	
Back	
Marker	

[RR/2]

Pattern Provided by:

Iowa Paint Horse Show

Ranch Reining (All Classes)

Show Date: Octobe 13-14 /2018

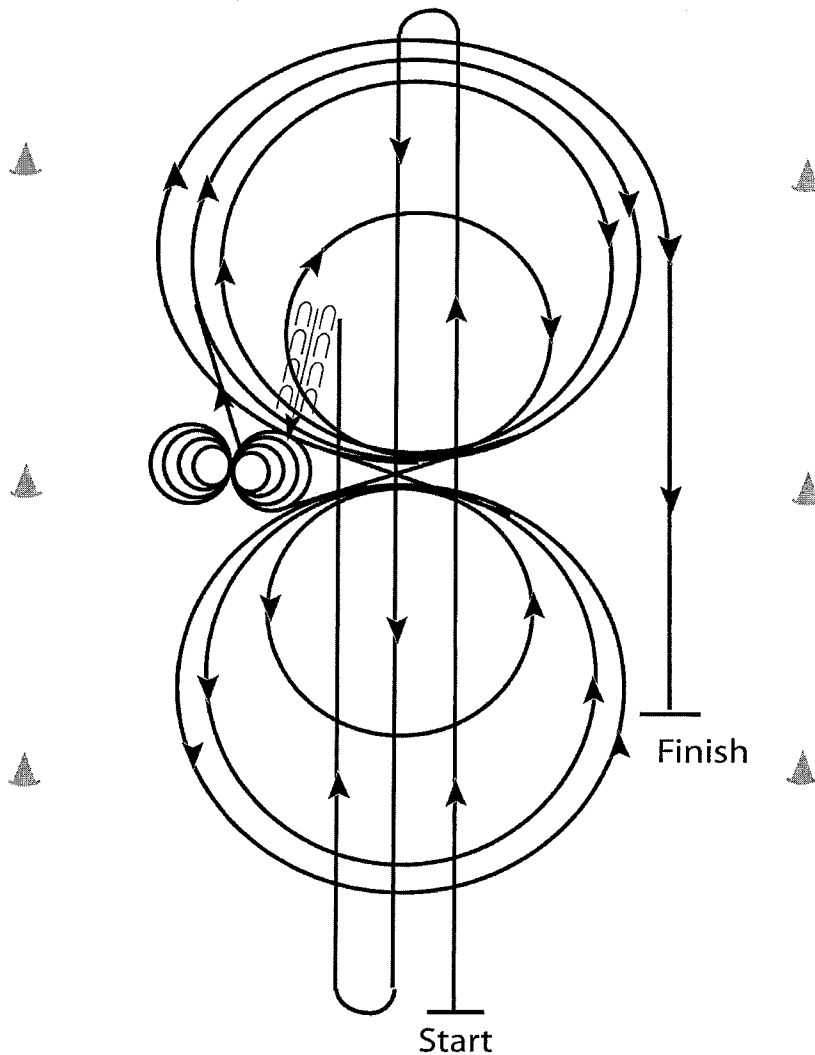

1. Run at speed to the far end of the arena past the end marker and do a left rollback – no hesitation.
2. Run to the opposite end of the arena past the end marker and do a right rollback – no hesitation.
3. Run past the center marker and do a sliding stop. Back up to the center of the arena at least ten feet (3m). Hesitate.
4. Complete four spins to the right.
5. Complete four and one-quarter spins to the left so that horse is facing left wall or fence. Hesitate.
6. Beginning on the right lead, complete three circles to the right: the first two circles large and fast; the third circle small and slow. Change leads at the center of the arena.
7. Complete three circles to the left: the first two circles large and fast; the third circle small and slow. Change leads at the center of the arena.
8. Begin a large fast circle to the right but do not close this circle. Run straight down the right side of the arena past the center marker and do a sliding stop at least twenty feet (6.09m) from the wall or fence. Hesitate to demonstrate completion of the pattern.
Rider may drop bridle to the designated judge.

[R/AQHAP-7]

Pattern Provided by:

WWW.HORSESHOWPATTERNS.COM

WWW.HORSESHOWPATTERNS.COM

Iowa Paint Horse Show

Reining (All Classes)

Show Date: Octobe 13-14 /2018

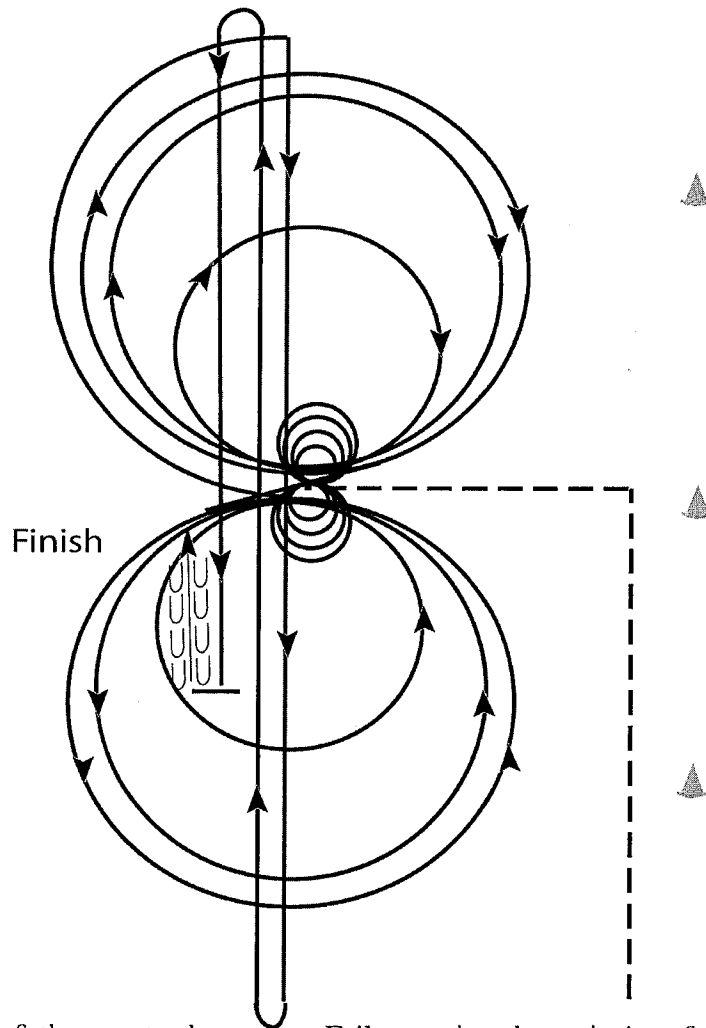

Horses must jog the majority of the way to the center. Failure to jog the majority of the way to the center will result in a 0 for failure to complete the pattern as written. Horses must wal or stop prior to starting pattern. Begin at the center of the arena facing the left wall or fence.

1. Complete four spins to the left. Hesitate.
2. Complete four spins to the right. Hesitate.
3. Beginning on the right lead, complete three circles to the right; the first small and slow; the next two circles large and fast. Change leads at the center of the arena.
4. Complete three circles to the left; the first small and slow; the next two circles large and fast. Change leads at the center of the arena.
5. Begin a large circle to the right, but do not close this circle. Run down the center of the arena past the end marker and do a right rollback - no hesitation. C
6. Run up the middle to the opposite end of the arena past the end marker and do a left rollback - no hesitation.
7. Run past the center marker and do a sliding stop. Back up to the center of the arena or at least 10 feet (3m). Hesitate to demonstrate completion of pattern.

[R/AQHAP-11]

Pattern Provided by: